

# FIBER LASER MARKING MACHINE



## > No Consumables, Long lifespan Maintenance Free

The Fiber laser source has super long lifespan of over 100,000 hours without any maintenance. No need to spare any extra consumer parts at all. Suppose you will work for 8 hours per day, 5 days a week, A fiber laser could work properly for you for more than 8-10 years without extra costs except electricity.

## > Multi-functional

It could Mark/Code/Engrave un-removable serials Numbers, batch Numbers, Expiry info, Best Before date, logo & any Characters that you want. It could also mark QR code.

## > Simple Operation, Easy to use

Our patent software supports almost all common formats, The operator does not have to understand programming, Just simply set a few parameters and click start.

## > High Speed Laser Marking

The laser marking speed is very fast, 3-5 times than the traditional marking machine.

## > Optional rotary axis for different cylindrical

Optional rotary axis can be used to mark on different cylindrical, spherical objects. The stepper motor is used for digital control, and the speed can be automatically controlled by computer, which is more convenient, simple, safe and stable.

# PARAMETER

**FOSTER**Reliable professional  
Laser equipment supplier!

Laser Type	Fiber Laser Marking Machine
Working area	110*110/150*150/200*200/300*300(mm)
Laser power	10W/20W/30W/50W
Laser wavelength	1064nm
Beam quality	$m^2 < 1.5$
Application	metal and partial nonmetal
Marking Speed	7000 mm/second
Repeated Precision	$\pm 0.003$ mm
Working voltage	220V / or 110V (+-10%)
Cooling Mode	Air Cooling
Supported graphic formats	AI, BMP, DST, DWG, DXF, DXP, LAS, PLT
Controlling software	EZCAD
Working temperature	15°C-45°C
Optional parts	Rotary Device, Lift platform, other customized Automation
Warranty	2 year
Package	Plywood

# APPLICATION **FOSTER**

Reliable professional  
Laser equipment supplier!

Fiber laser marking machine can work with most metal marking applications, such as Gold, Silver, Stainless Steel, Brass, Aluminium, Steel, Iron etc. and can also mark on many non-metal materials, such as ABS, Nylon, PES, PVC, Makrolon.



U disks



Gear



Nameplate



Phone shell



Surgical Instruments



Bearings



Ruler



Metal cup



Tool



Pen



Nameplate



Lighter



Coating Aluminum

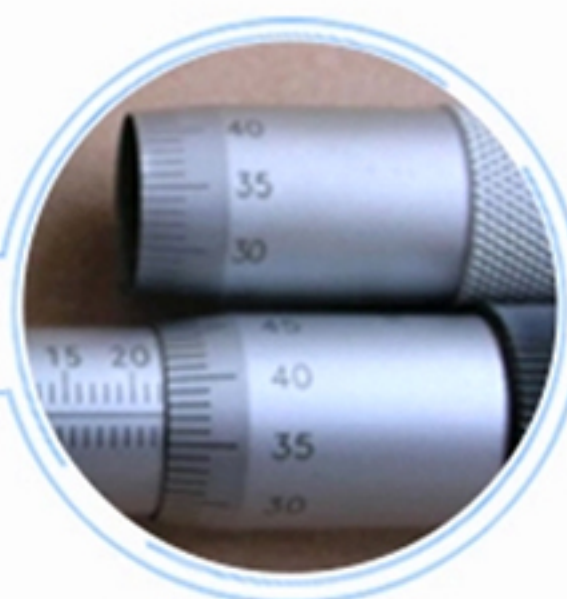

Rotary marking



Color marking



Gold/Silver Ring



SD card



Lamp head



Meters



Nail polish



Button



Power Bank



Bank card



Animal Ear Tags



Capacitors



Cosmetic Boxes



Ceramic



Glasses

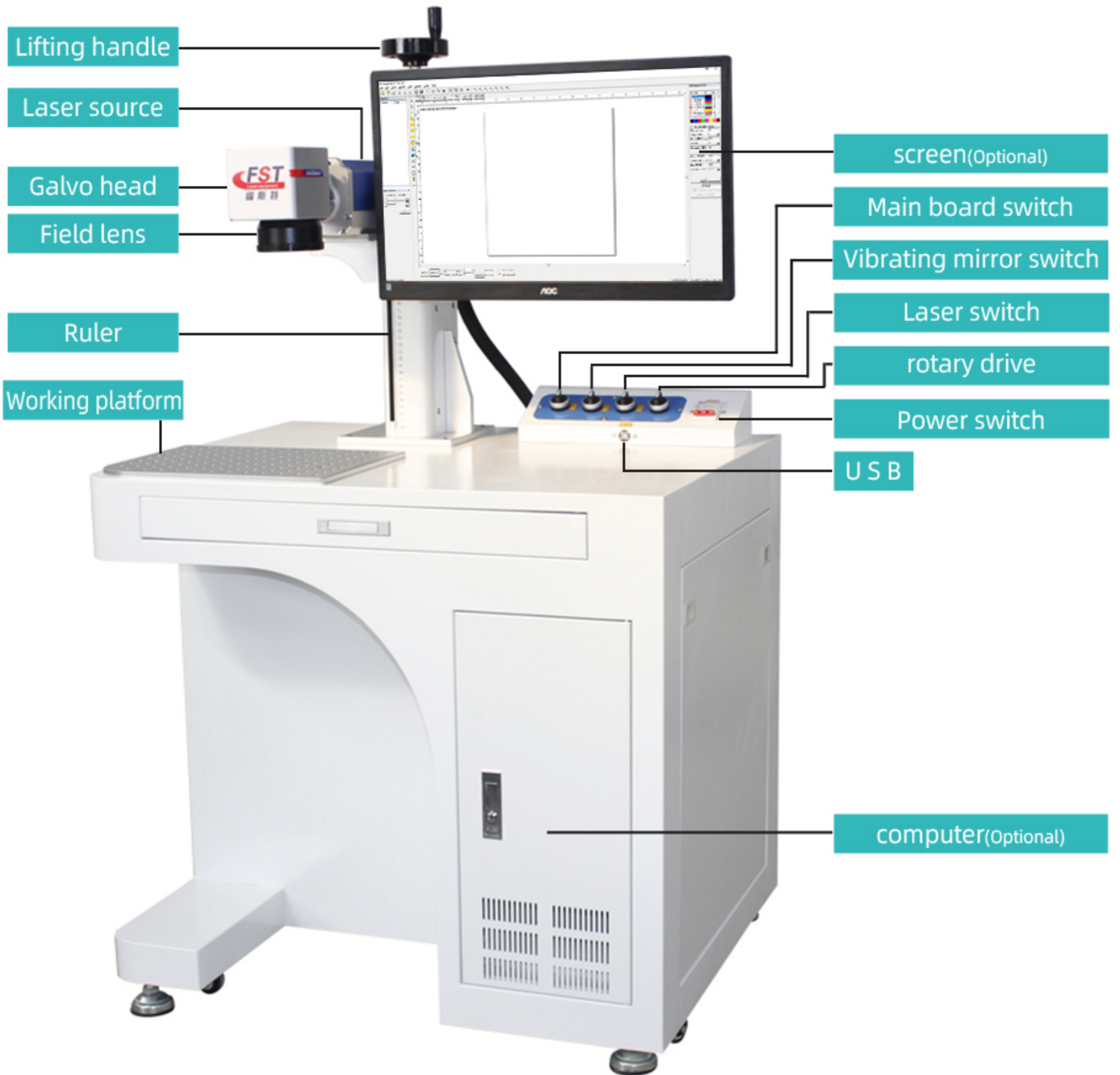

# DETAILS

**FOSTER**

Reliable professional  
Laser equipment supplier!

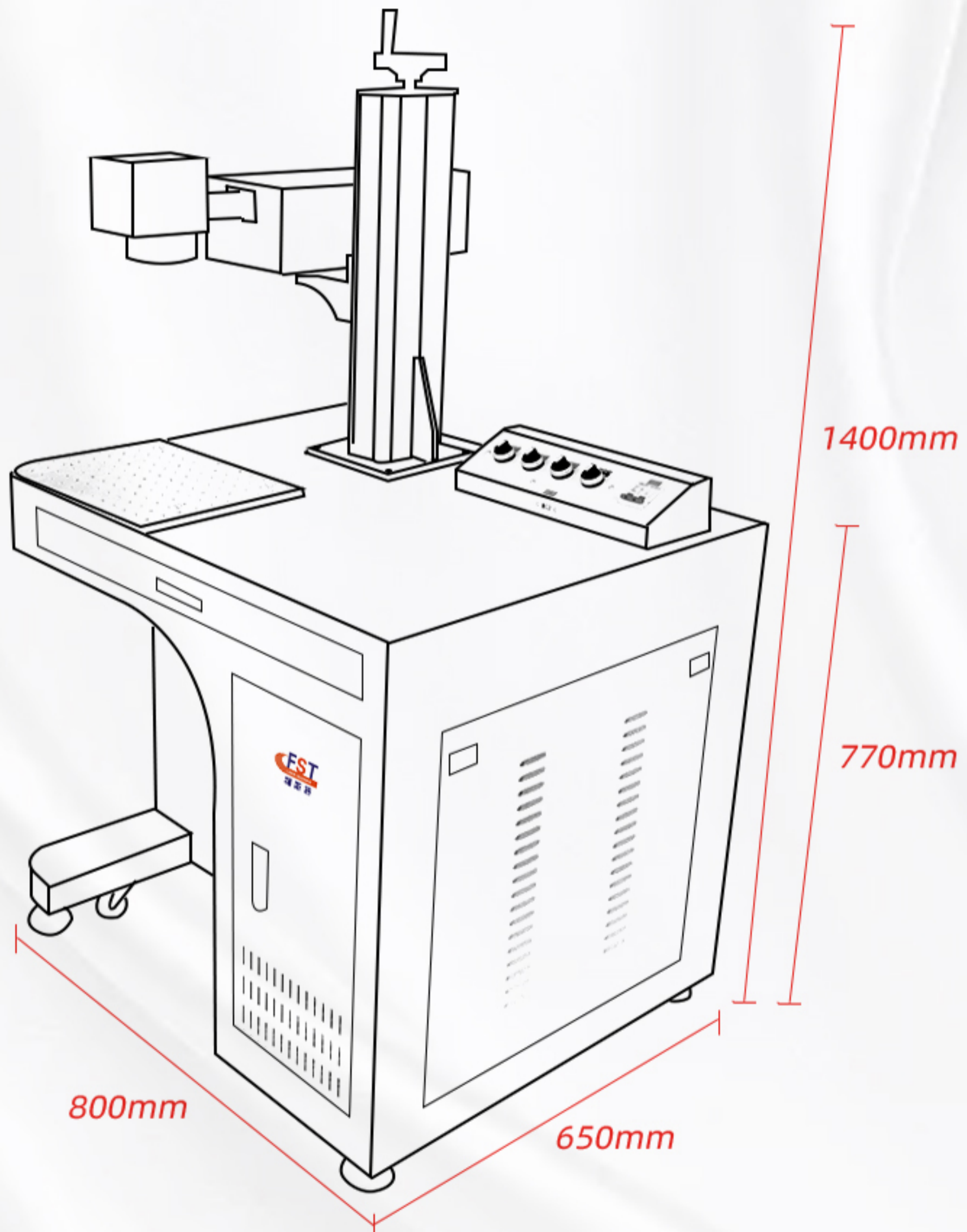



## »» FIELD LENS

We use famous brand to provides precision laser. Standard 110 x 110mm marking area. Optional 150x150mm , 200 x200mm,300x300mm etc.

## »» GALVO HEAD

Famous brand Sino-galvo, high speed galvanometer scan adopting SCANLAB technology, digital signal, high precision and Speed.

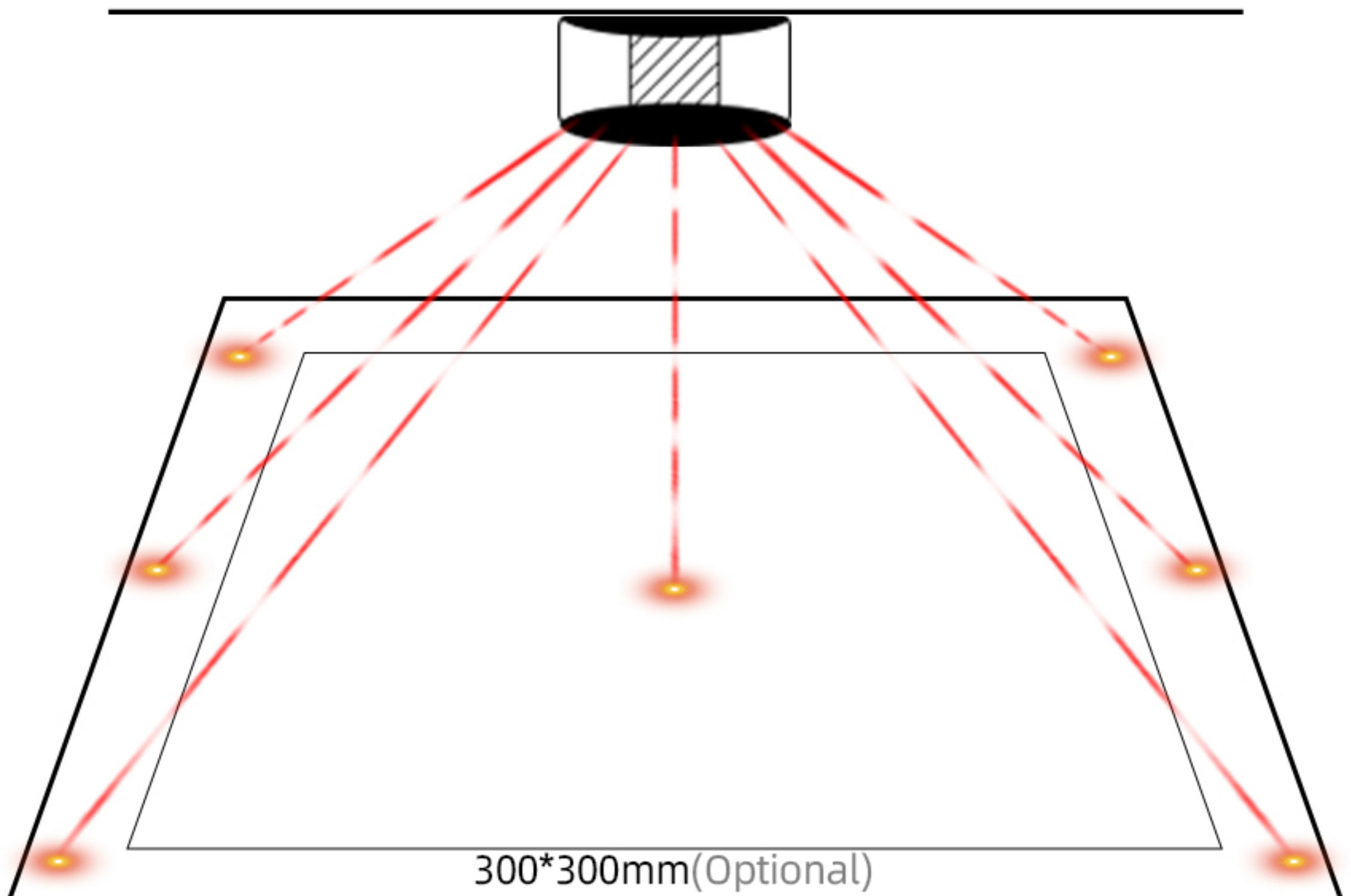

## » LASER SOURCE

We use Chinese famous brand Max laser source. Optional: IPG / JPT / Raycus laser source.

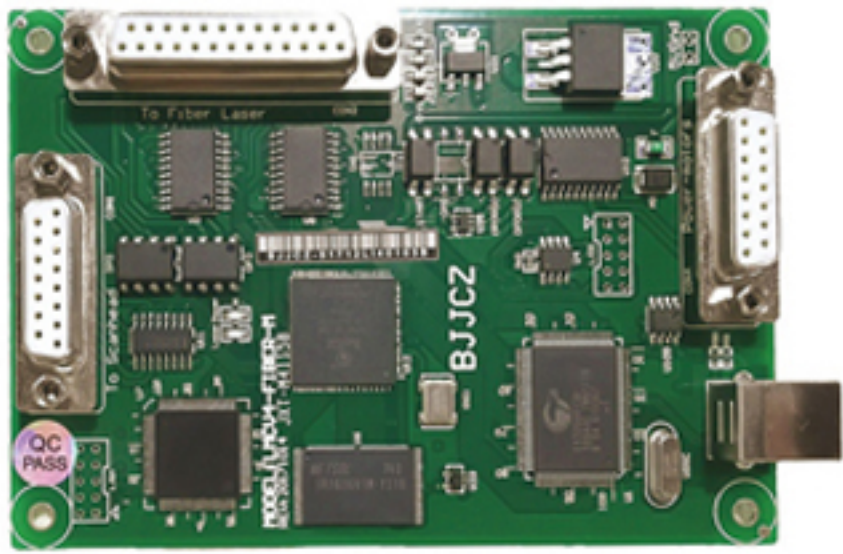
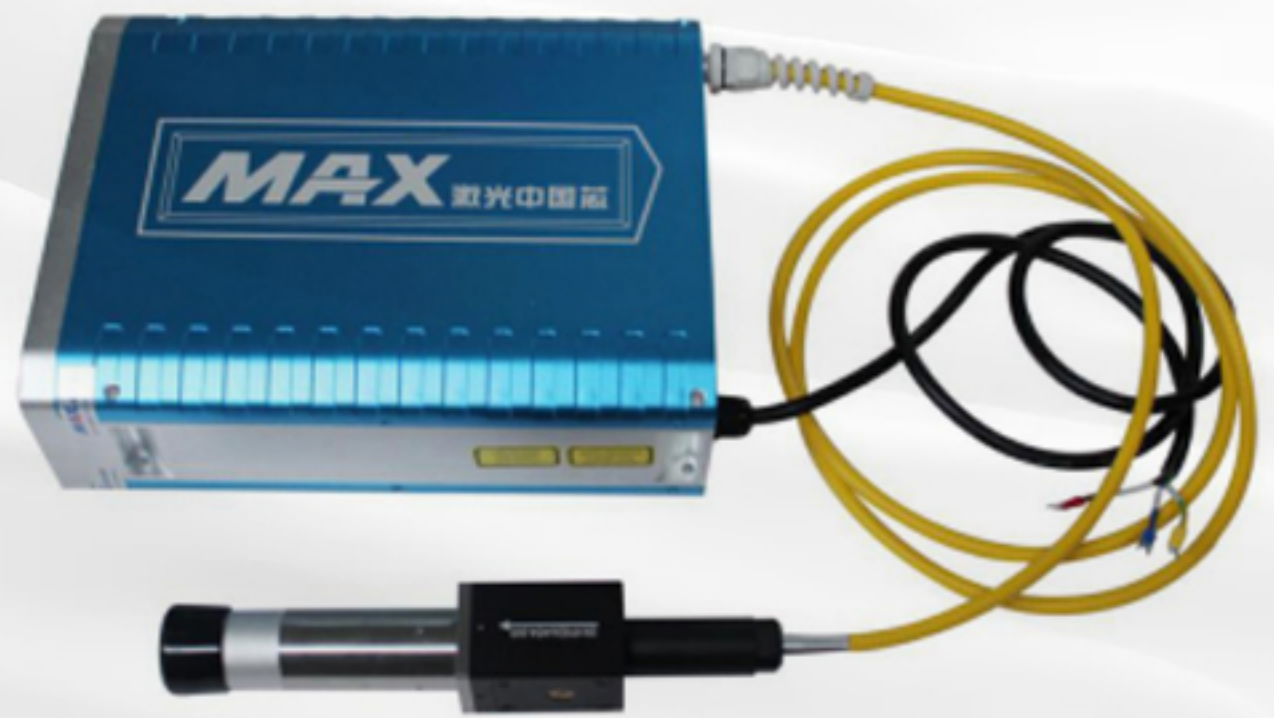

## » JCZ CONTROL BOARD

Ezcad genuine products, user-friendly interface, functional diversity, high stability, high precision.

Each board has its own number to ensure that it can be inquired in the original factory. Refuse to fake.

## » THE CONTROL SOFTWARE

1. Powerful editing function.
2. Friendly interface.
3. Easy to use.
4. Support Microsoft Windows XP, VISTA, Win7, Win10 system.
5. Support ai, dxf, dst, plt, bmp, jpg, gif, tga, png, tif and other file formats.
6. Support for TrueType fonts, single line fonts (JSF), SHX fonts, dot matrix fonts (DMF), 1D bar codes and 2D bar codes. Flexible variable text processing, changing text in real time during processing, can directly read and write text files, SQL databases and Excel file.

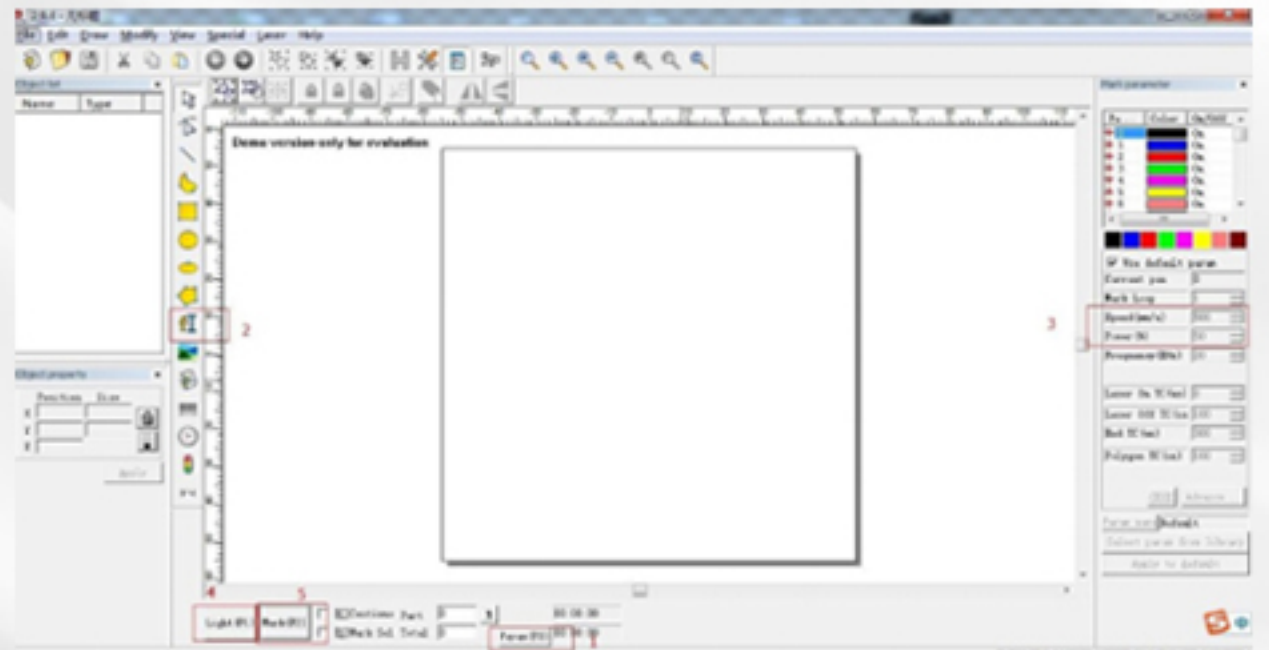

## » DOUBLE RED LIGHT POINTER (OPTIONAL)

When two red light coincides best focus. Double red light pointer help customers make focus quickly and easily.



## » RED LIGHT PREVIEW

Adopt Red light preview to show the laser path since laser beam is invisible.

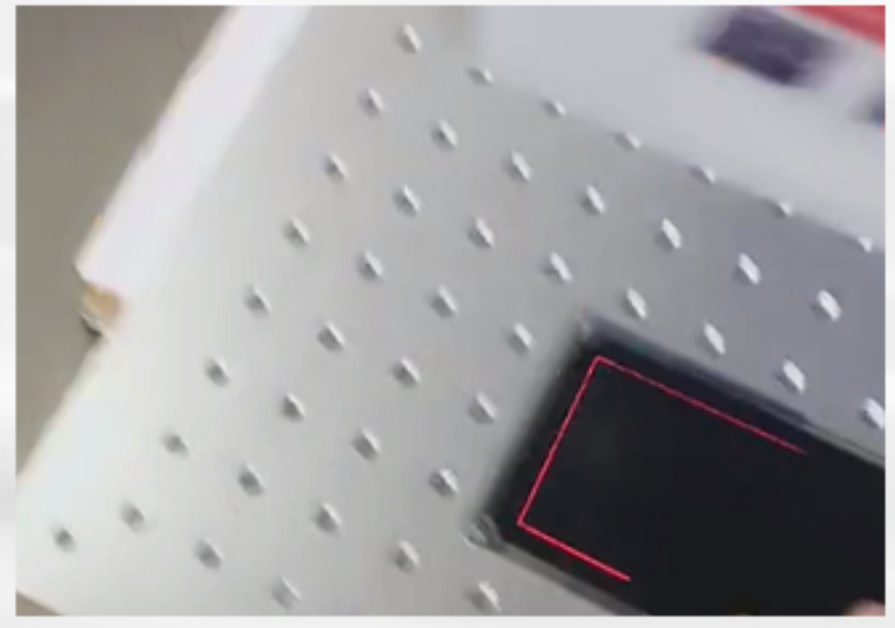

## » MARKING RULER AND ROTATING HANDLE

Enables customers to precisely position for fast engraving.  
Adapting To Different Products Height



**FST**  
Laser equipment  
福斯特

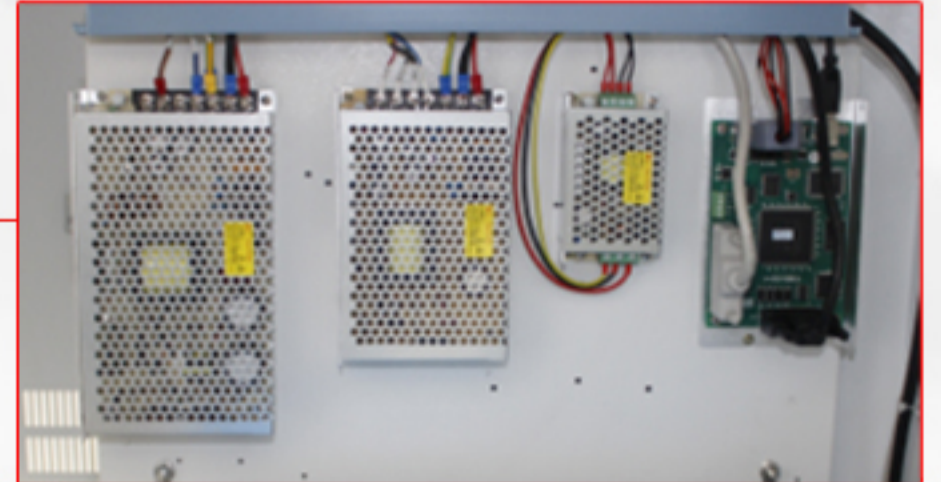

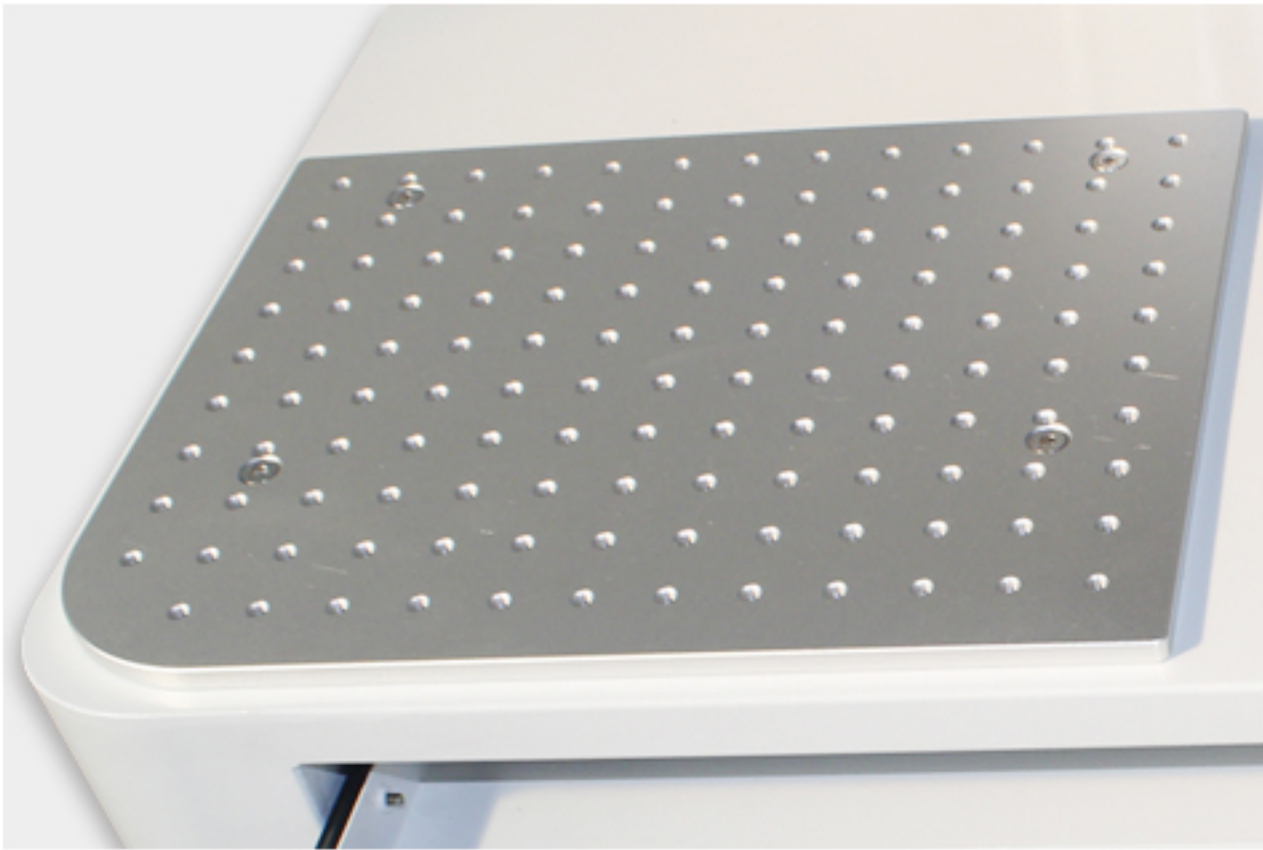

## »» WORKING PLATFORM

Alumina working platform and imported precise beeline device. Flexibility mesa have multiple screw holes, convenient and custom installation, special fixture industry platform.

## »» FOOT SWITCH

It can control the laser on and off. make the operate more convenient.



## »» GOGGLES (OPTIONAL)

Can protect eyes from laser wave 1064nm, let the operate more safe.

## » ROTATION AXIS AND PLATFORMS (OPTIONAL)

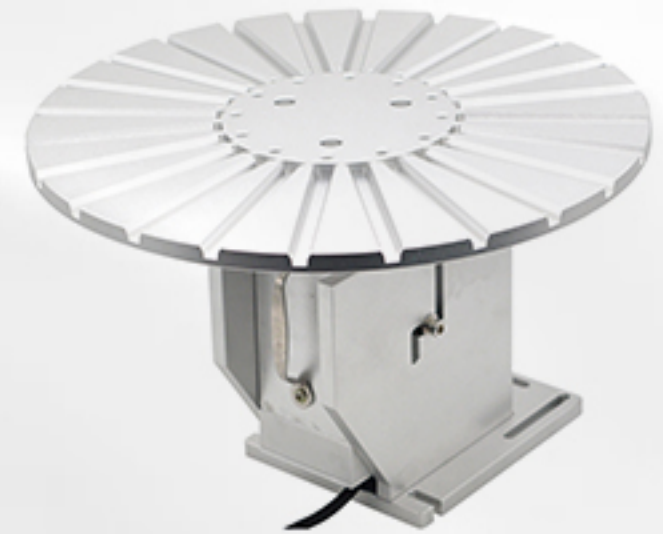

ROTARY CHUCK

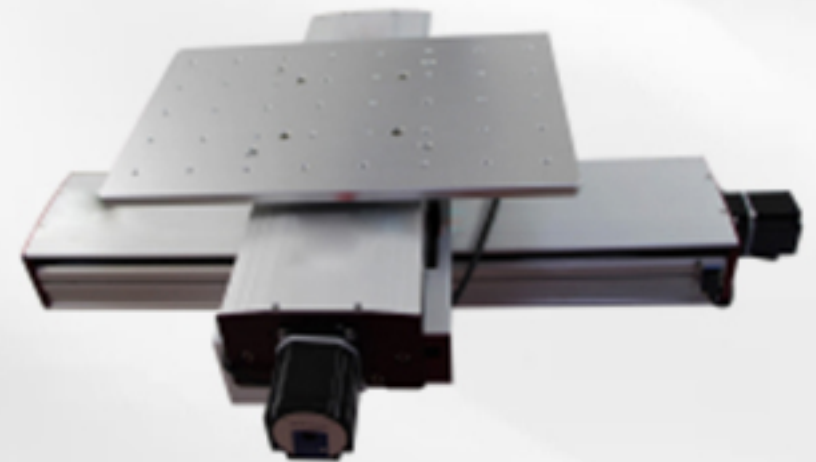
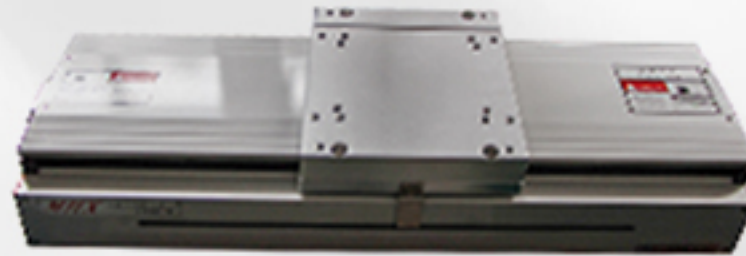
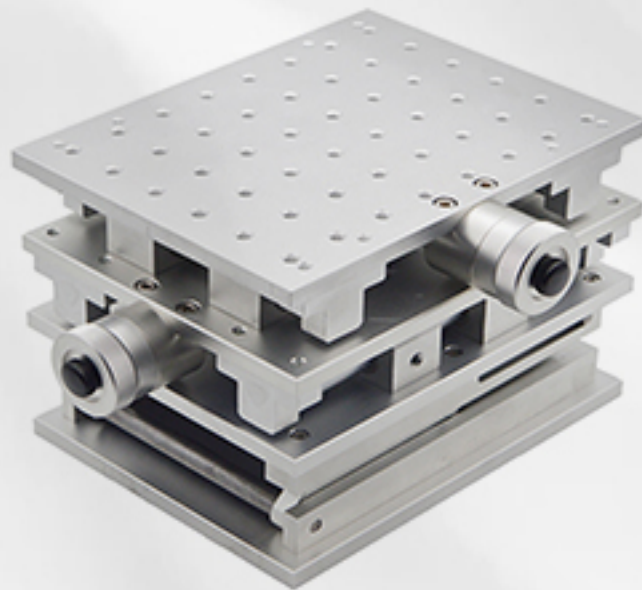

2D / 3D TABLE AND EXTENDED PLATFORM

# DELIVER GOODS

**FOSTER**

Reliable professional  
Laser equipment supplier!



Protective oil processing



Wrapping with  
protective film

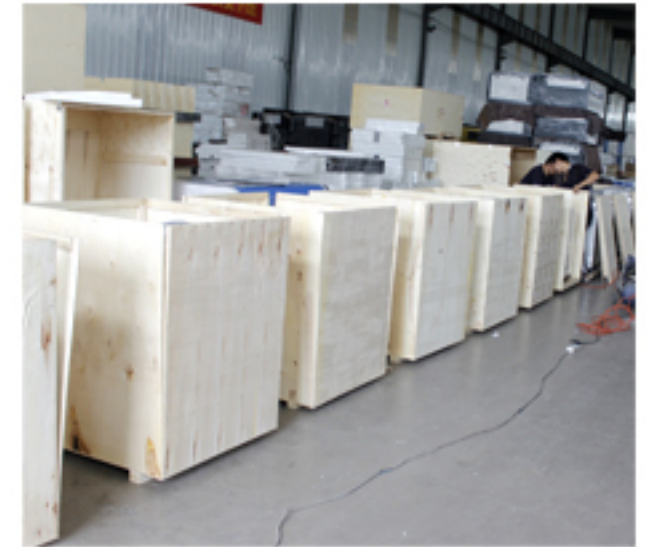

Wooden box sealing



Container Sealing  
and Transportation



container loading



Forklift moving goods

# ENCLOSURE

**FOSTER**

Reliable professional  
Laser equipment supplier!



Tool protection



Focal length ruler



Data Line



Power Cord, Ground wire



U disk



Wrench



Foot Switch



Positioning strip (optional)

# COMMENTS

**FOSTER**

Reliable professional  
Laser equipment supplier!

Supplier Service: **Acceptable** (3 stars) 03 Aug 2020  
On-time Shipment: **Very satisfied** (5 stars)



china cheap laser engraving machine 4060 laser engr...

★★★★★

Fosterlaser is the best supplier on Al  
ibaba I have met

👍 0

Supplier Service: **Very satisfied** (5 stars) 25 May 2020  
On-time Shipment: **Very satisfied** (5 stars)

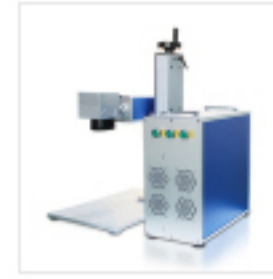

20W fiber laser marking machine

★★★★★

Honest and good seller.  
Sent everything on time  
(even considering the gl  
obal epidemic at the ti  
me of my order). The m  
achine came well packe  
d. Nothing is damaged,  
everything works, the ki  
t is complete, exactly w  
hat we agreed on. So all  
is well, I am completely  
satisfied. Thanks!

👍 0

Supplier Service: **Very satisfied** (5 stars) 03 Aug 2020  
On-time Shipment: **Very satisfied** (5 stars)



3kw cnc fiber laser cutting machine for 12mm Iron al...

★★★★★

The machine is perfect and the servi  
ce is professional, I am very satisfied

👍 0



Supplier Service: **Very satisfied** (5 stars) 12 Jun 2020  
On-time Shipment: **Very satisfied** (5 stars)



50w fiber laser marking machine 50w raycus with rot...

★★★★★

great service and trustworthy! will de  
finitely buy again!!

👍 0

Supplier Service: **Very satisfied** (5 stars) 17 May 2020  
On-time Shipment: **Very satisfied** (5 stars)



30w RF LASER MARKING MACHINE

★★★★★

Fast delivery, I recomm  
end. I look forward to a  
nother purchase

👍 0



# Our certificate

Foster Laser Technology Co., Ltd.



# Company and Factory

Liaocheng Foster Laser Science&Technology Co.,Ltd is a professional manufacturer of laser engraving machine,laser cutting machine,laser marking machine for 12years .Since 2004, Foster Laser focused on the development and production of various types of laser engraving/cutting/marking machine with the advanced management,strong research strength and steady globalization strategy, Foster Laser establish more perfect product sales and service system in China and around the world, make the world's brand in laser industry.

Our target is "scientific management, high quality, high reputation and takes continuous development as our policy, regards customers as our center, double win with our customers", and we adhere to our tenet of "take the market demand as the guide, continue to take innovation and make improvement". We will try our best to provide the high quality products and perfect service for clients.

Furthermore,we pay much attention to after-sales service. Good service and good quality is same important for Foster Laser will follow the spirit "Credibility and Integrity", try best to provide customer more super product and better service.

Foster Laser--reliable professional Laser equipment supplier!

Welcome to cooperate with us and achieve win-win!





# Office and Team



# Our Exhibition



# Our services

- 
- A woman in a blue shirt and headset is working on a laptop. The background is a light blue gradient with a faint image of the woman and her laptop.
1. warranty for 2 years.
  2. Maintenance for whole life.
  3. We will provide the consumable parts at an agency price.
  4. 24 hours online service, free technical support.
  5. Machine has been adjusted before delivery, operation disk is included in the delivery. If there is any other questions, pls kindly tell me.
  6. We have manual instruction and U drive (Guiding Videos) for software Installation, operation and machine's using and maintenance.