

# 1060 NEW STYLE LASER CUTTING MACHINE



## THREE LINES LINEAR GUIDE

High accuracy, High speed



## RUIDA CONTROLLER SYSTEM

Offline use, Easy to operate

## FAMOUS LASER TUBE

EFR, RECI, CDWG, YONGLI, JOY (optional)



## PASS THROUGH DOOR

Front and back feed

## TWO-PART SPLIT MACHINE

Save space, save freight, through the narrow door



## HIGH COST PERFORMANCE

The same price, the best performance and quality



# PRODUCT DETAILS

LIAOCHENG FOSTER LASER SCIENCE & TECHNOLOGY CO., LTD.

Model	FST-1060 New style
Worktable	honeycomb or Aluminum knife
Engraving area	1000*600mm
Laser Power	50W/60W/80W/100W/130W/150W
Engraving Speed	500mm/s Max
Cutting Speed	60mm/s
Cutting Depth (Acrylic)	0-20mm (acrylic)
Up and down work table	Up and down adjustable
Minimum Shaping Character	English 1×1mm (Chinese Characters 2*2mm)
Resolution Ratio	0.0254mm (1000dpi)
Power Supply	220V(or110V)+/-10% 50Hz
Resetting Positioning	Accuracy less than or equal to 0.01mm
Water protecting sensor and alarm	Yes
Operating Temperature	0-45°C
Operating Humidity	35-70°C
Graphic Format Supported	PLT/DXF/BMP/JPG/GIF/PNG/TIF
Operation System	Windows XP/Windows 7/8/10
Software	Rdworks/ CorelDRAW/ AutoCAD
Control Configuration	Ruida
Water Cooling(Yes/No)	Yes
Laser Tube	Sealed CO2 glass lasertube

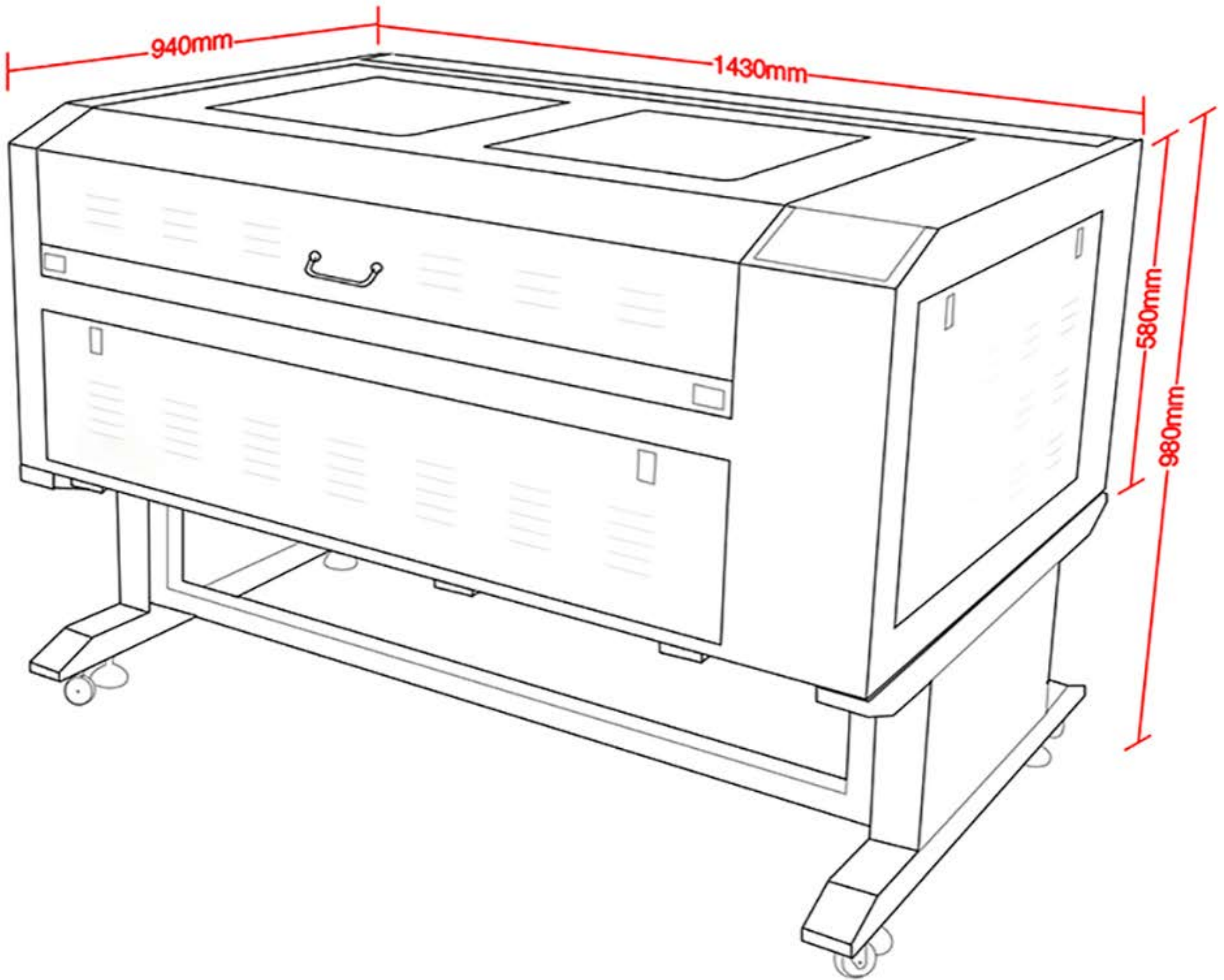



# FEATURE

LIAOCHENG FOSTER LASER SCIENCE & TECHNOLOGY CO., LTD.

Foster laser CO2 Laser Engraving Machine with different working area, laser power or working table, which application is engraving and cutting on acrylic, wood, fabric, cloth, leather, rubber plate, PVC, paper and other kinds of non metal materials. 1060 laser cutting machine are widely used in clothing, shoes, luggage, computer embroidery clipping, model, electronic appliances, toys, furniture, advertising decoration, packaging and printing, paper products, handicrafts. Household appliances, laser processing and other industries.



New style

- 1 Aluminum knife or honeycomb table. Two kinds of tables are available for different material.
- 2 CO2 Glass sealed laser tube China famous brand (EFR, Reci), good beam mode stability, long service time.
- 3 Imported lens and mirrors. High transmittance, good focusing, reflection effect.
- 4 Ruida Controller system, support online/offline working, English language system, adjustable cutting speed and power.
- 5 High accuracy stepper motors and drivers. Belt transmission.
- 6 Tiwan Hiwin Linear square guide rails, higher precision.
- 7 Open style, the front and back of the machine is open which is possible for longer material, breakthrough the limit of the workpiece length.
- 8 Rotate cutting available.



# DETAIL DISPLAY

LIAOCHENG FOSTER LASER SCIENCE & TECHNOLOGY CO., LTD.

## WORK AREA

1000x600mm work area



Honeycomb worktable\*



Aluminum knife\*

\*You can choose one or two. It depends on the needs of the customer.

## INDUSTRIAL LASER HEAD

High precision retractable laser head, easy to adjust focal length, equipped with red light positioning system, accurate positioning, reduce material loss.

Auto-blowing to protect laser head and prevent the laser burning.



## LASER TUBE

Closed Co2 laser tube, long life, stable power. Installation of reinforcement settings, the laser tube is not easy to collide and cause damage when moving the machine.

(EFR, RECI, CDWG, YONGLI, JOY. Optional)





## USA II-VI LENS

Imported USA II-VI Lens, suitable for various environments, and has high precision and high speed.



## FAMOUS BRAND BELT

The ONK brand belt, wear resistance, good stability, compact structure and low noise.

## LEADING CHAIN

The current lead and breather pipe are included in it.  
Thicker, more stable  
Keep the laser head from shaking



## REFLECTOR

45° mirror adjustment set.  
Easy to adjust laser path.

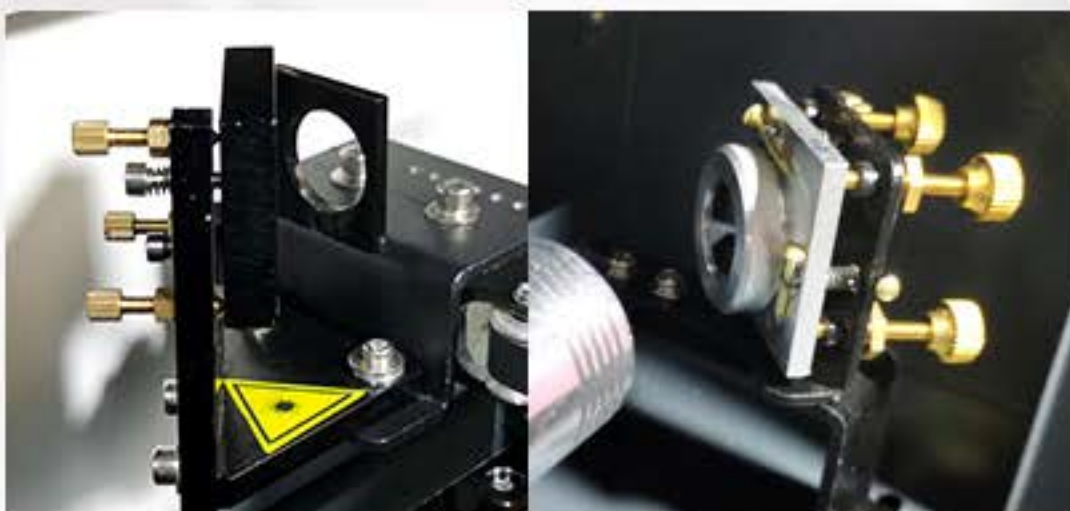



## CONTROL PANEL

1. Adopt advanced laser engraving and cutting control system: Ruida RDC6442 control system, the control panel support different language include Chinese, English, French, Pyccko, Portuguese, Turkish, German, Spanish, Vietnamese, Korean, Italian.



2. Standard RDWorksV8 software: It support 15 different languages, include: Chinese, English, Japanese, French, German, Portuguese, Polish, Spanish, Russian, Korean, Vietnamese, Indonesian, Italian, Turkish, Arabic.

It can compatible with many other software, like Coreldraw, Photoshop, AutoCAD, TAJIMA, etc.

You can use these software to make designs, then import to Rdworks to cut or engrave.

3. RDworks software support files in different format: AI, DXF, PLT, DST, BMP, DSB, EPS, DAT, NC, RDB, GIF, JPG, JPEG, JPE, JFIF, PNG, MNG, ICO, CUR, TIF, TIFF, TGA, PCX, WBMP, WMF, EMF, JBG, J2C, JPC, PGX, RAS, PNM, PGM, PPM, SKA, RAW,

4. Storage: The main board has EMS Memory which enables the user to store more than 100 files.

5. Laser output control: Can regulate the laser power from 1-100% according to different material.

6. Interface: USB2.0 interface support connect to computer by USB cable, it also support offline work.



Wifi Control(optional)



Mobile App(optional)



Multi-lanquage

Free upgrade to  
RD-6445





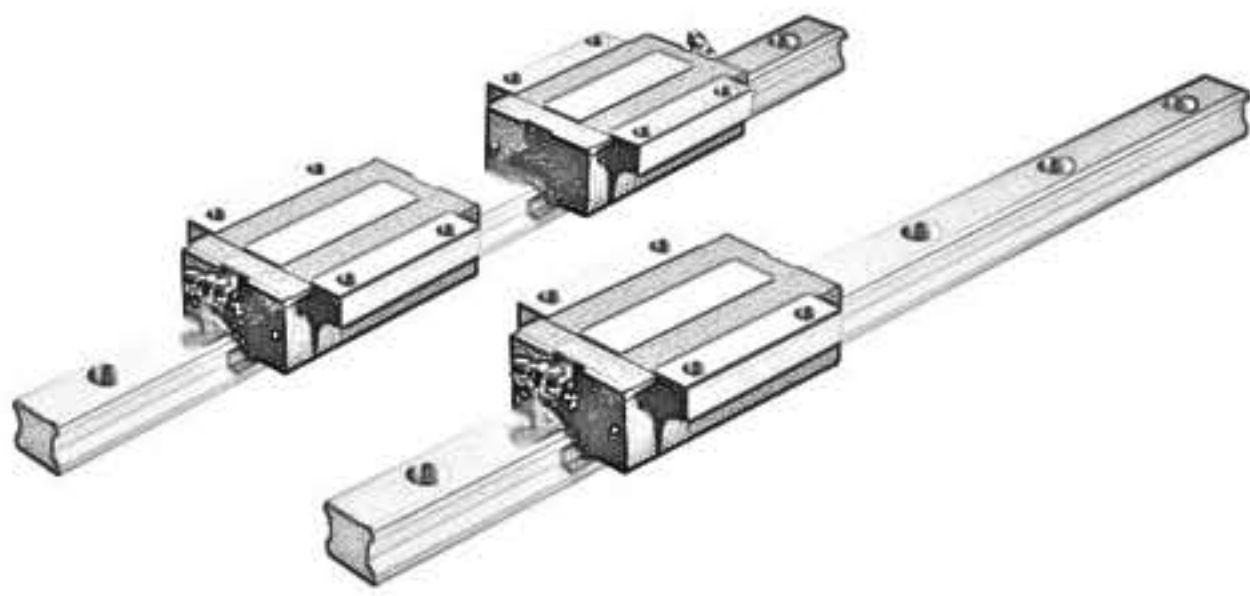

## LINEAR GUIDE

XY axis apply imported square rails. Ensures stable operation, high precision and long life.

## PLATFORM LIFTING

It allows you to process materials of various sizes, can be lifted in Z direction (up-and-down) to get more working space.

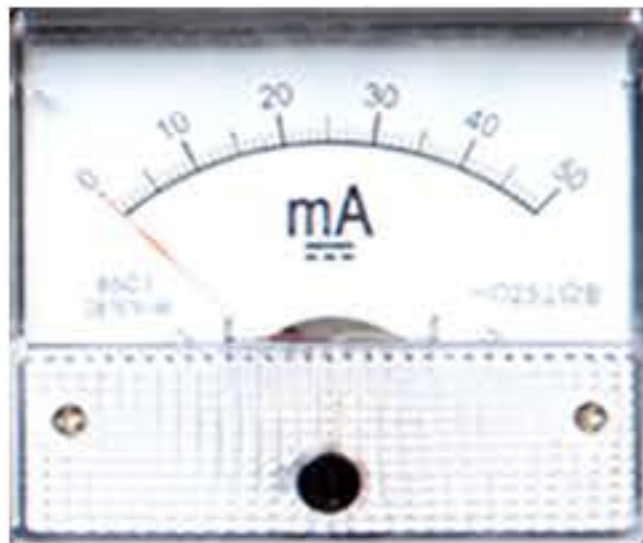

## AMPEREMETER

The ammeter can detect whether the laser tube current is normal. (Optional)

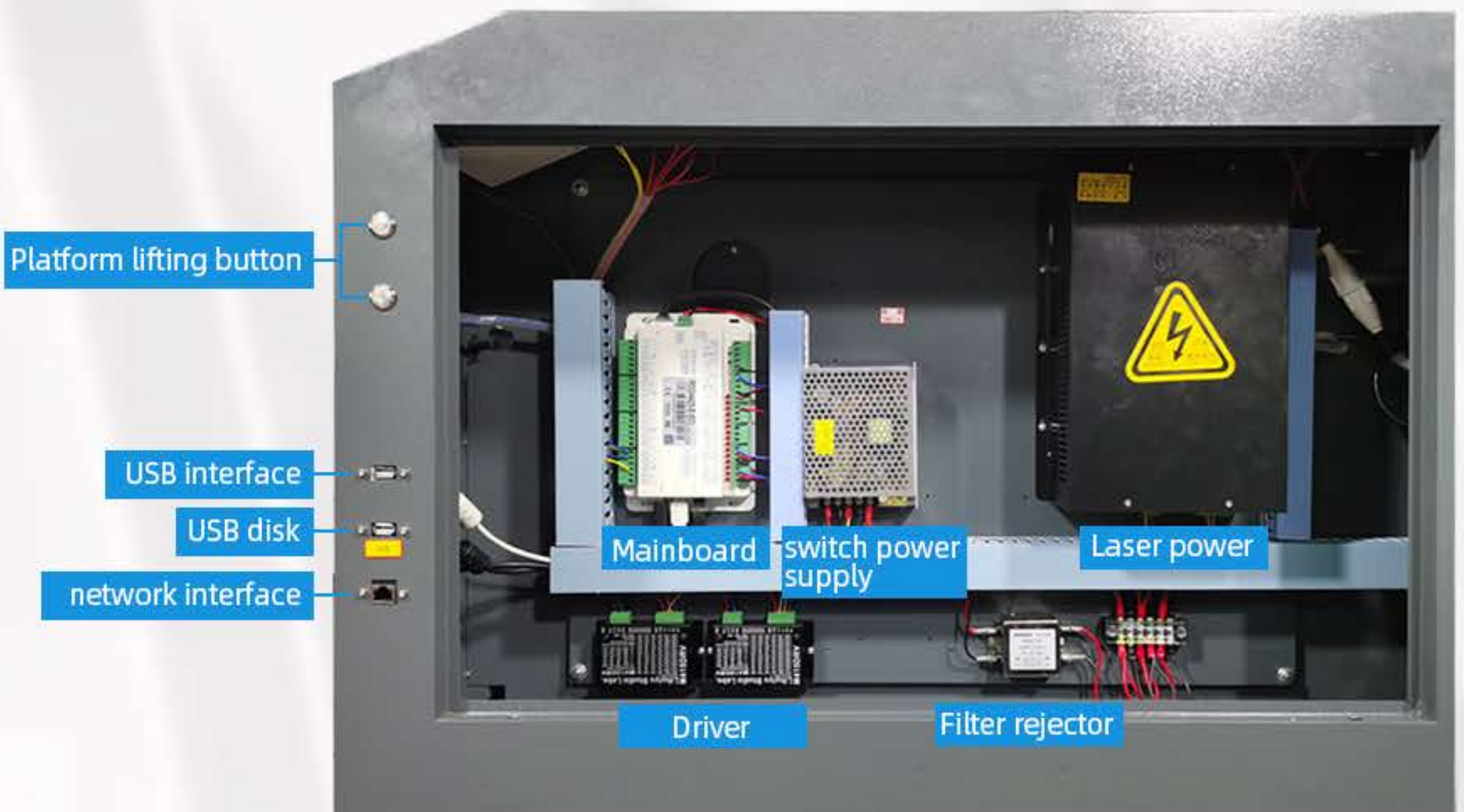





Coreldraw



CAD

### SUPPORTED SOFTWARE

Coreldraw and CAD control directly Advanced working software which can be embedded into Coreldraw and CAD, User can operate the machine buy Cor-edraw or CAD software directly.

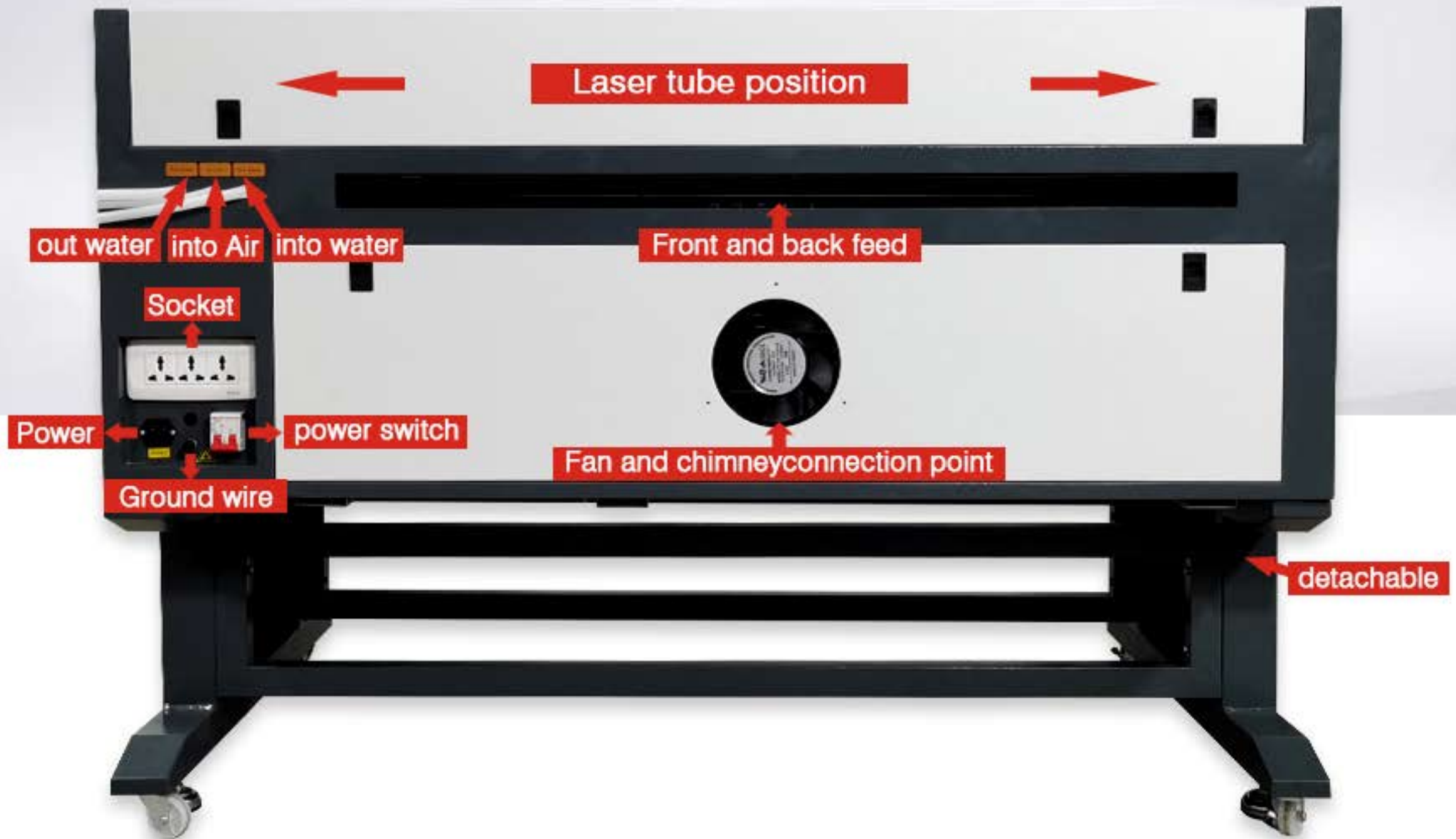



# Our certificate

Foster Laser Technology Co., Ltd.





# PRODUCT ACCESSORIES

LIAOCHENG FOSTER LASER SCIENCE & TECHNOLOGY CO., LTD.



Air Pump



Chimney



Water pump



Tool protection



Data Line



CD or U disk



Focal length ruler



Power Cord



Tool box



Exhaust fan



Cardan wheel



Instruction Manual

## Optional accessories



Simple rotary axis



Standard rotary axis



S&A Water chiller  
CW-3000 / CW-5000



# PRODUCT APPLICATION

LIAOCHENG FOSTER LASER SCIENCE & TECHNOLOGY CO., LTD.

## applicable materials:

Acrylic, leather, wood, rubber, double-color board, MDF, plywood, bamboo, paper, cardboard, marble, granite, stone, glass, fabric, textile, coated metal, painted metal, anodised aluminum etc.

ACRYLIC

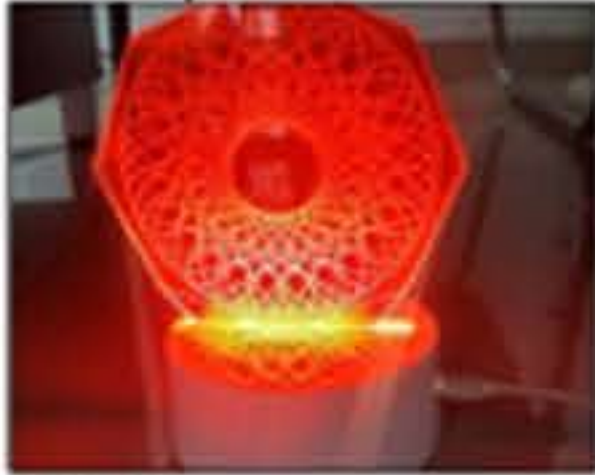

GLASS



CERAMICS



FELT



IRREGULAR SHAPE



FOAM

STONE



LEATHER



PAPER



PLASTIC



SILICONE



TWO COLOR PLATES



WOOD



WOODCUT





# applicable industries:

Arts and crafts, advertising, decoration, wood working, leather manufacturing, packaging, printing, mould making, furniture, clothing and brand making etc.



## Applicable material for reference

Material	Engrave	Cut	Material	Engrave	Cut
Natural wood	√	√	Paper	√	√
Acrylic	√	√	Mylar	√	√
Glass	√	×	Press board	√	√
Double color plate	√	√	Rubber	√	√
Bamboo	√	√	Plywood	√	√
MDF	√	√	Fiberglass	√	√
Cloth	√	√	Painted metal	√	√
Leather	√	√	Plastic	√	√
Marble	√	×	Ceramic	√	×
Matte boards	√	√	Coated Metal	√	×
Stone	√	×	Other materials	Inquire us, we will test for you	

## Cutting thickness of different laser power for reference

Laser power (W)	Acrylic(mm)	Plywood(mm)	MDF(mm)
40W	3	2	1.5
60W	8	5	3
80W	12	8	6
100W	15	12	9
150W	25	20	15

\* The above data is for reference only



# PACKAGING DELIVERY

LIAOCHENG FOSTER LASER SCIENCE & TECHNOLOGY CO., LTD.



Machine cleaning and  
Protective oil processing



Wrapping with  
protective film



Wooden box sealing



Container Sealing  
and Transportation



container loading



Forklift moving goods



# OUR REVIEWS

LIAOCHENG FOSTER LASER SCIENCE & TECHNOLOGY CO., LTD.

Supplier Service: **Very satisfied** (5 stars)  
On-time Shipment: **Very satisfied** (5 stars)



9060 laser engraving machine

★★★★★

Great service from Fosterlaser, very quick to communicate and very well packaged. Easy to assemble and accuracy is great. I would 100% recommend this company.



Supplier Service: **Acceptable** (3 stars)  
On-time Shipment: **Very satisfied** (5 stars)



1390 LASER CUTTING MACHINE FOR METAL AND N...

★★★★★

very limited info, hard to get tech support. Didn't know I needed an oxygen cylinder, but machine is awesome.

Supplier Service: **Very satisfied** (5 stars)  
On-time Shipment: **Very satisfied** (5 stars)

17 May 2020



6090 100 watt co2 laser engraving machine with ruid...

★★★★★

Product shipped super fast even during this covid-19 times when other sellers took ages. Everything came as described, and packed very well. If you want laser machine don't get it from anyone else.

0

Supplier Service: **Very satisfied** (5 stars)  
On-time Shipment: **Very satisfied** (5 stars)

10 Jul 2020



1390 cnc co2 laser cutting machine with CCD camera...

★★★★★

Good quality built and good support from the seller. Nice machine all around. Just had to find a version of corel draw in english. Laser was well aligned despite shipping and didn't have to do alignment myself. So very satisfied all around. I prefer using some industrial water...

[Read more](#)

0

Supplier Service: **Very satisfied** (5 stars)  
On-time Shipment: **Very satisfied** (5 stars)

12 Jun 2020



50w fiber laser marking machine 50w raycus with rot...

★★★★★

great service and trustworthy! will definitely buy again!!

0

Supplier Service: **Very satisfied** (5 stars)  
On-time Shipment: **Very satisfied** (5 stars)

22 Jun 2020



laser engraving machine for perfume bottle 50w 4060...

★★★★★

the machine came with no scratches and no any damage, also the supplier was to active and helped me even after purchasing

0

Supplier Service: **Very satisfied** (5 stars)  
On-time Shipment: **Very satisfied** (5 stars)

25 May 2020



Factory directly 150w 180w 220w RD6442S recil stainl...

★★★★★

wow just wow very great product. very satisfied customer here..the seller is very responsive..thank you so much

0





 Trade Assurance

## Protect Your Alibaba.com Orders

Trade Assurance protects online orders when payment is made through Alibaba.com.

 Product Quality

 On Time Shipment





# Company and Factory

Liaocheng Foster Laser Science&Technology Co.,Ltd is a professional manufacturer of laser engraving machine,laser cutting machine,laser marking machine for 12years .Since 2004, Foster Laser focused on the development and production of various types of laser engraving/cutting/marking machine with the advanced management,strong research strength and steady globalization strategy, Foster Laser establish more perfect product sales and service system in China and around the world, make the world's brand in laser industry.

Our target is "scientific management, high quality, high reputation and takes continuous development as our policy, regards customers as our center, double win with our customers", and we adhere to our tenet of "take the market demand as the guide, continue to take innovation and make improvement". We will try our best to provide the high quality products and perfect service for clients.

Furthermore,we pay much attention to after-sales service. Good service and good quality is same important for Foster Laser will follow the spirit "Credibility and Integrity", try best to provide customer more super product and better service.

Foster Laser--reliable professional Laser equipment supplier!

Welcome to cooperate with us and achieve win-win!





# Office and Team





# Our Exhibition

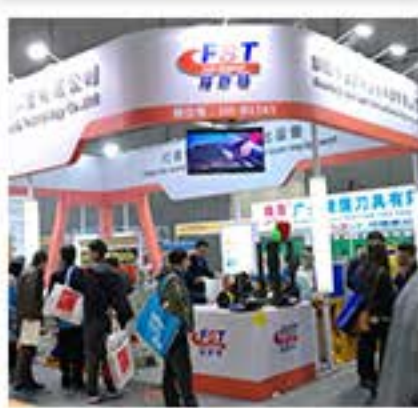
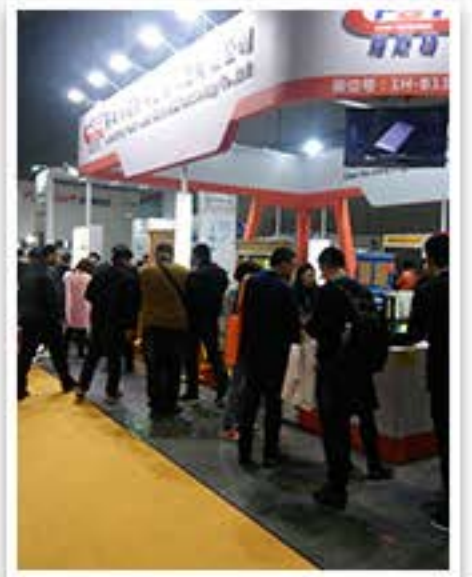
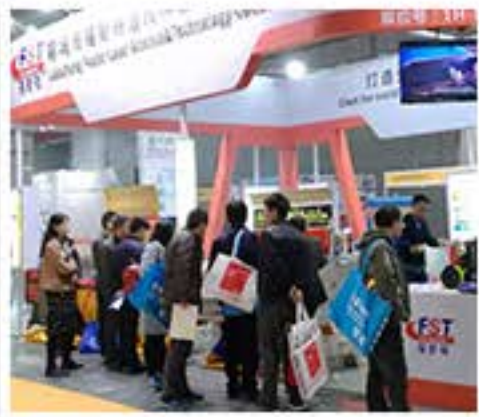
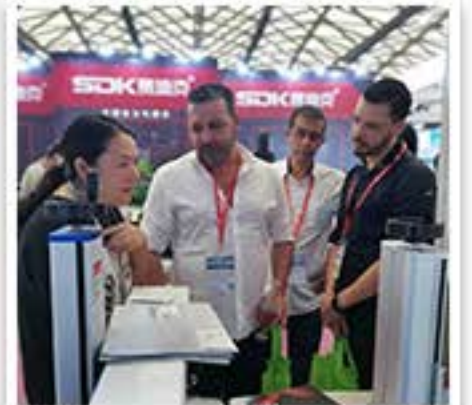
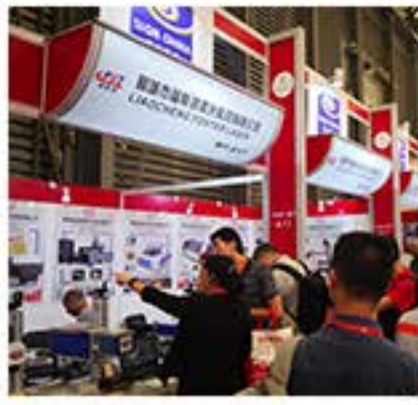
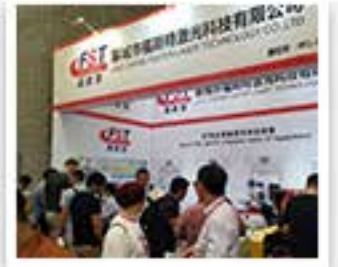
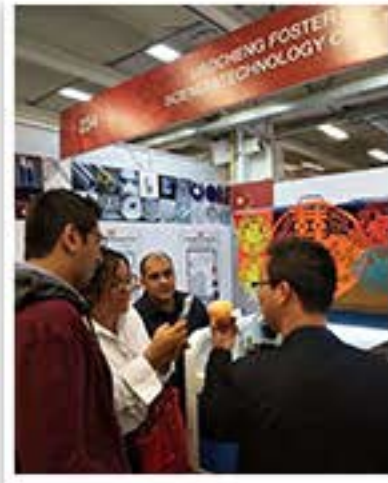
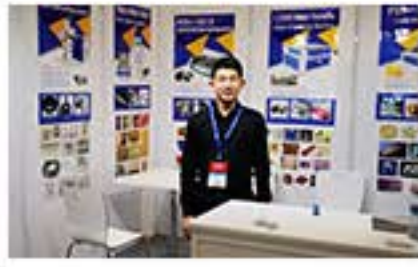



# F A Q

**Q1. Before sending me an inquiry on our cnc laser, it is better for you to provide me the following information:**

1)Your metal or non-metal material size. Because in our factory, we have different models according to working area.

2)Your materials.

Metal/Acrylic/plywood/MDF?

3)You want to engrave or cut?

If cut, could you tell me your cutting thickness? Because different cutting thickness need different laser tube power and laser power supplier.

**Q2. If we don't know how to use the machine,can you teach us?**

Yes, We will send you manual and guide video in English, it can teach you how to operate the machine. If you still can not learn how to use it, we can help you by "Teamviewer" online helpsoftware.Or we can talk by phone, email or skype

**Q3.How long is the delivery time?**

For standard machines, it would be 3-5 days; For non-standard machines and customized machines according to client's specific requirements, it would be 7 to 10 days.

**Q4. Quality Control:**

The whole production procedure will be under regular inspection and strict quality control. The complete machine will be tested to make sure they can work very well before being out of factory. Our machine passed CE Certificate, meet European and American standard, were exported to more than 100 Countries.

**Q5. Do you arrange shipment for the machines?**

Yes, dear esteemed customers, for FOB or CIF price, we will arrange shipment for you. For EXW price, clients need to arrange shipment by themselves or their agents.

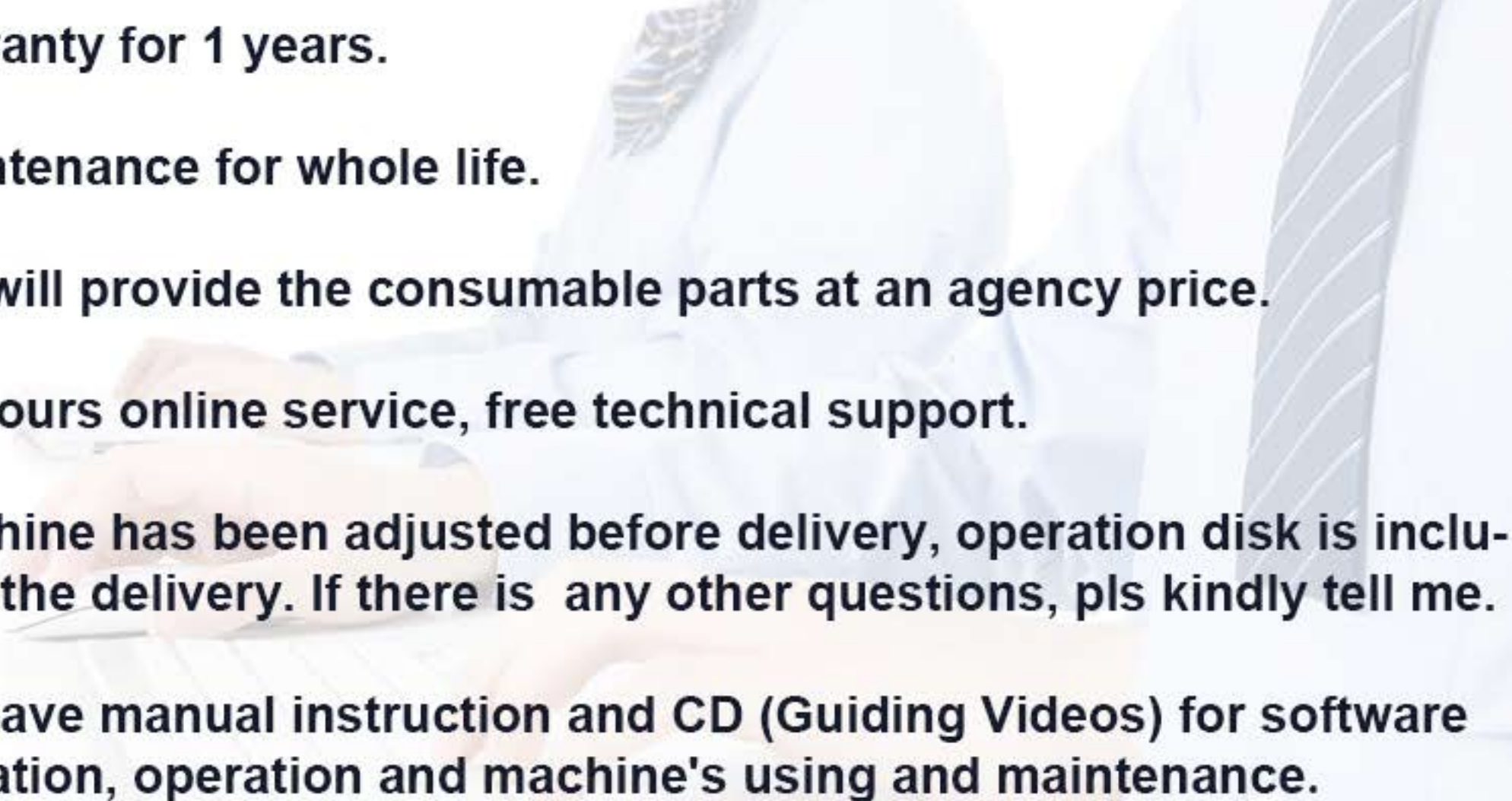

# Our services

- 
1. warranty for 1 years.
  2. Maintenance for whole life.
  3. We will provide the consumable parts at an agency price.
  4. 24 hours online service, free technical support.
  5. Machine has been adjusted before delivery, operation disk is included in the delivery. If there is any other questions, pls kindly tell me.
  6. We have manual instruction and CD (Guiding Videos) for software Installation, operation and machine's using and maintenance.