

LIAOCHENG FOSTER LASER SCIENCE & TECHNOLOGY CO., LTD.

1325 CO2 LASER CUTTING MACHINE

- MULTIFUNCTIONAL -

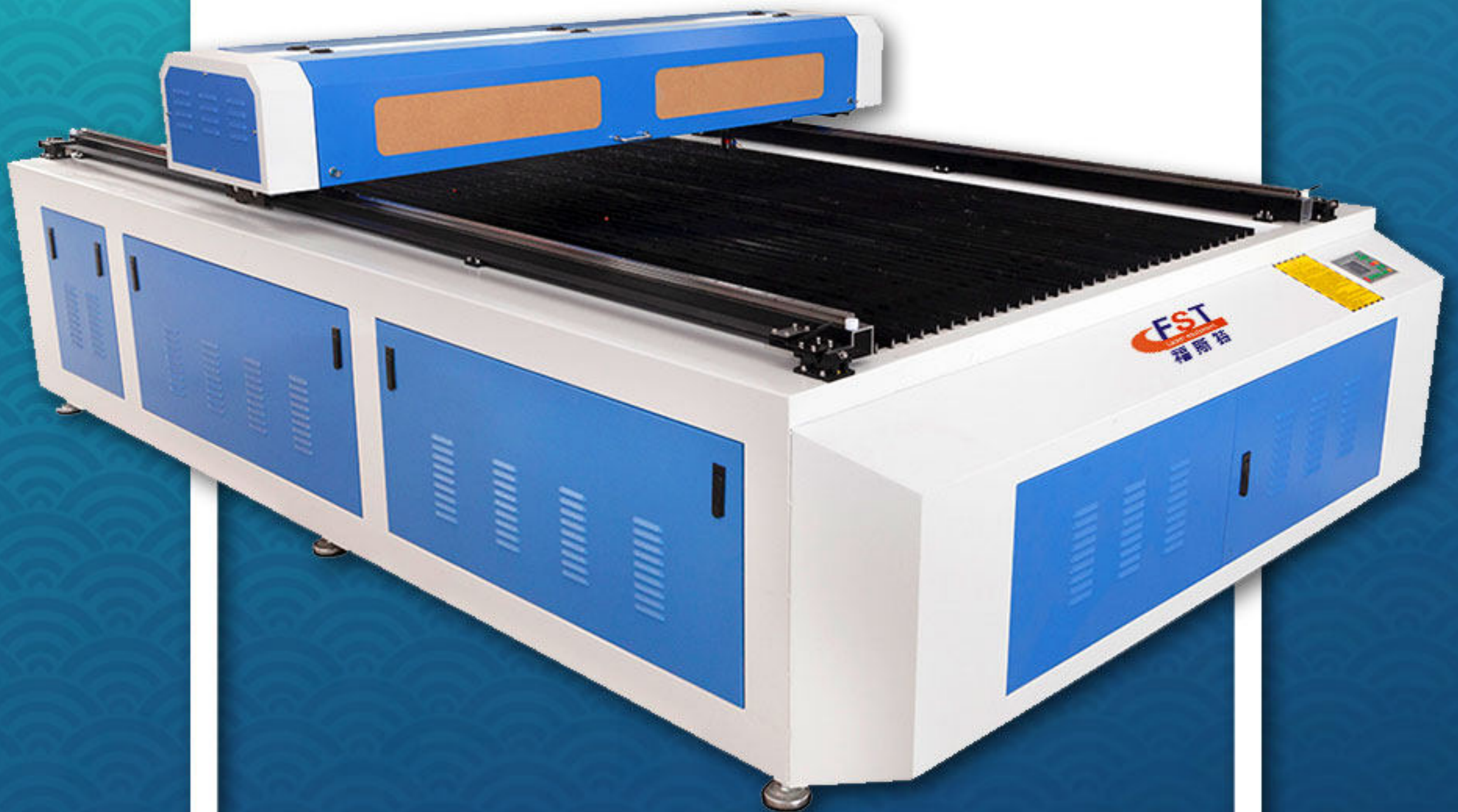

SELLING POINT

FOSTER LASER

1. Aluminum knife or honeycomb table. Two kinds of tables are available for different material.
2. CO2 Glass sealed laser tube China famous brand (EFR, RECI), good beam mode stability, long service time.
3. Imported lens and mirrors. High transmittance, good focusing, reflection effect.
4. Ruida Controller system, support online/offline working, English language system, adjustable cutting speed and power.
5. High accuracy stepper motors and drivers. Belt transmission.
6. Taiwan Hiwin Linear square guide rails, higher precision.
7. You can choose CCD CAMERA SYSTEM, it can do Auto Nesting+ Auto Scanning + Auto position recognition

PRODUCT DETAILS

FOSTER LASER

Model	FST-1325
Worktable	honeycomb or Aluminum knife
Engraving area	2500*1300mm
Laser Power	80W/100W/130W/150W/180W/
Engraving Speed	1200mm/s Max
Cutting Speed	0-500mm/s
Cutting Depth (Acrylic)	0-30mm
Resetting positioning accuracy	<0.01mm
Minimum Shaping Character	1 X 1mm
Power Supply	220V(or110V)+/-10% 50Hz
Software	Indirect output : ArtCut, Photoshop Direct output : CorelDraw, AutoCAD, Lasercut, Laserwork, LaserCAD, RDworks
Graphic Format Supported	PLT/DXF/BMP/AI
Operation System	Windows XP/VISTA/Win 7/Win 10
Cooling System	Water Cooling and protection system
Control system	DSP System
Machine Dimension	3210x2010x1160(mm)
Gross Weight	1100KGS

DETAIL DISPLAY

FOSTER LASER

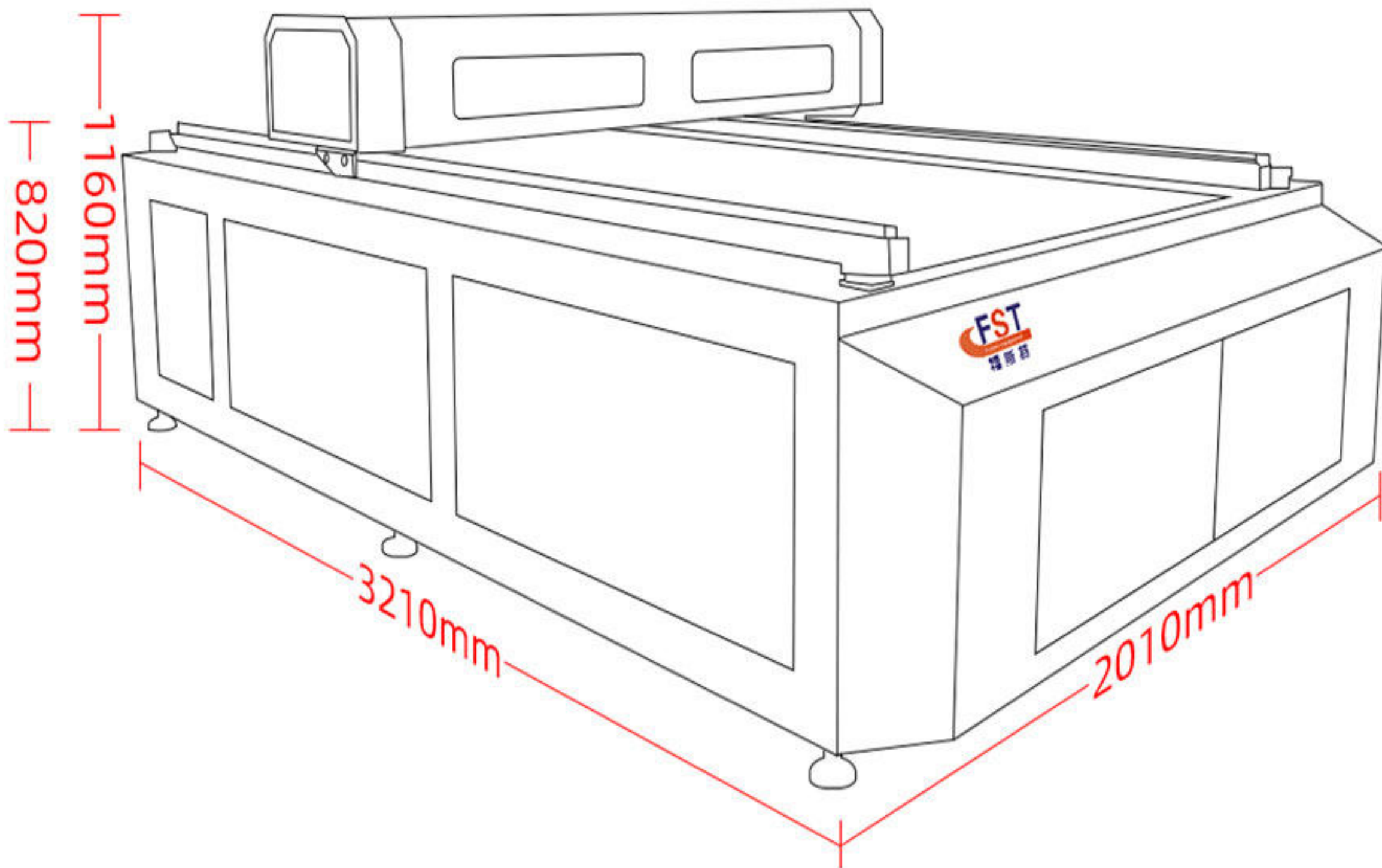

WORK AREA 2500X1300MM

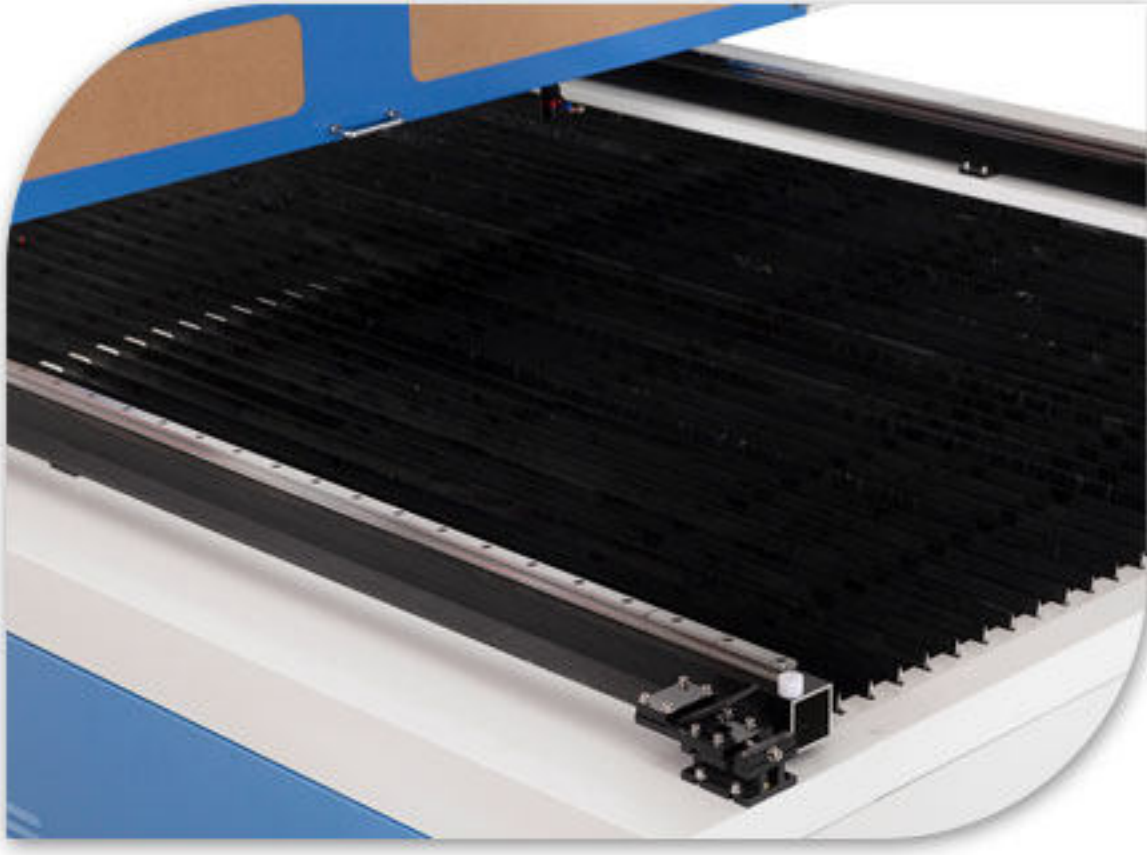

Aluminum knife

To process hard materials like acrylic, wood and so on.

Honeycomb worktable

- 1) Small holes make sure good supporting performance which is suitable for leather, cloth and other thin soft materials
- 2) The hole of honeycomb worktable is small, so the small workpiece can be placed on the table surface to be processed



IMPORTED LINEAR GUIDE

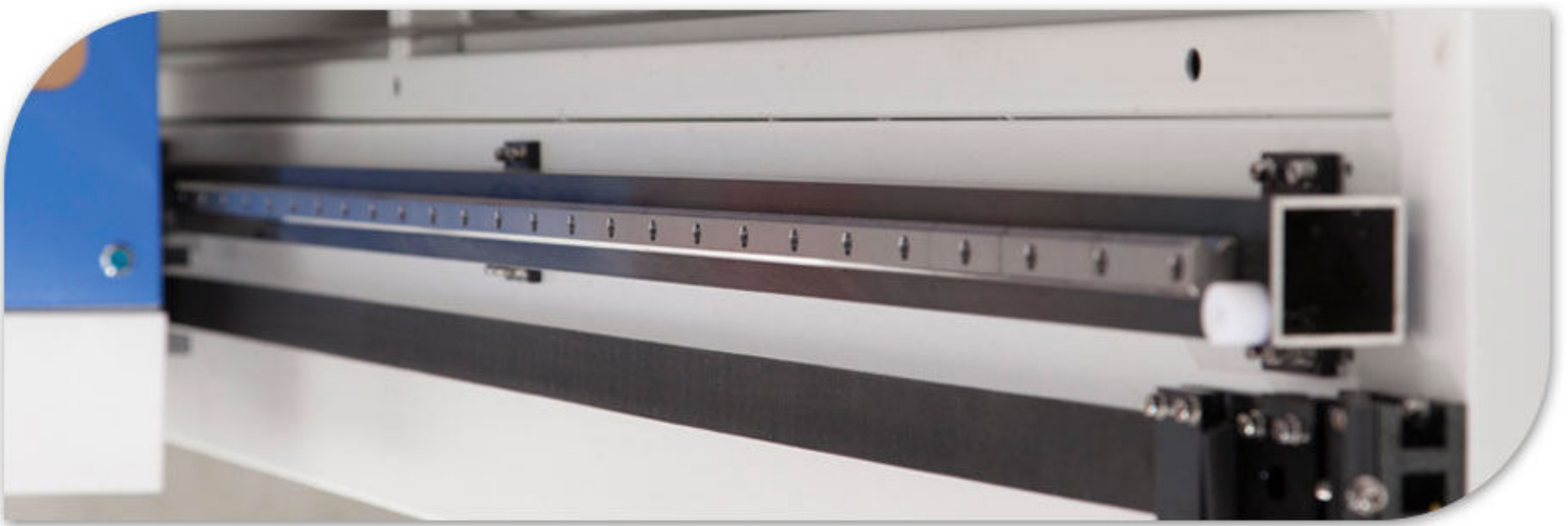

Three imported linear guides to make the cutting precision and curve of the work piece more precise and smooth

INDUSTRIAL LASER HEAD

×

High precision retractable laser head, easy to adjust focal length, equipped with red light positioning system, accurate positioning, reduce material loss. Auto-blowing to protect laser head and prevent the laser burning

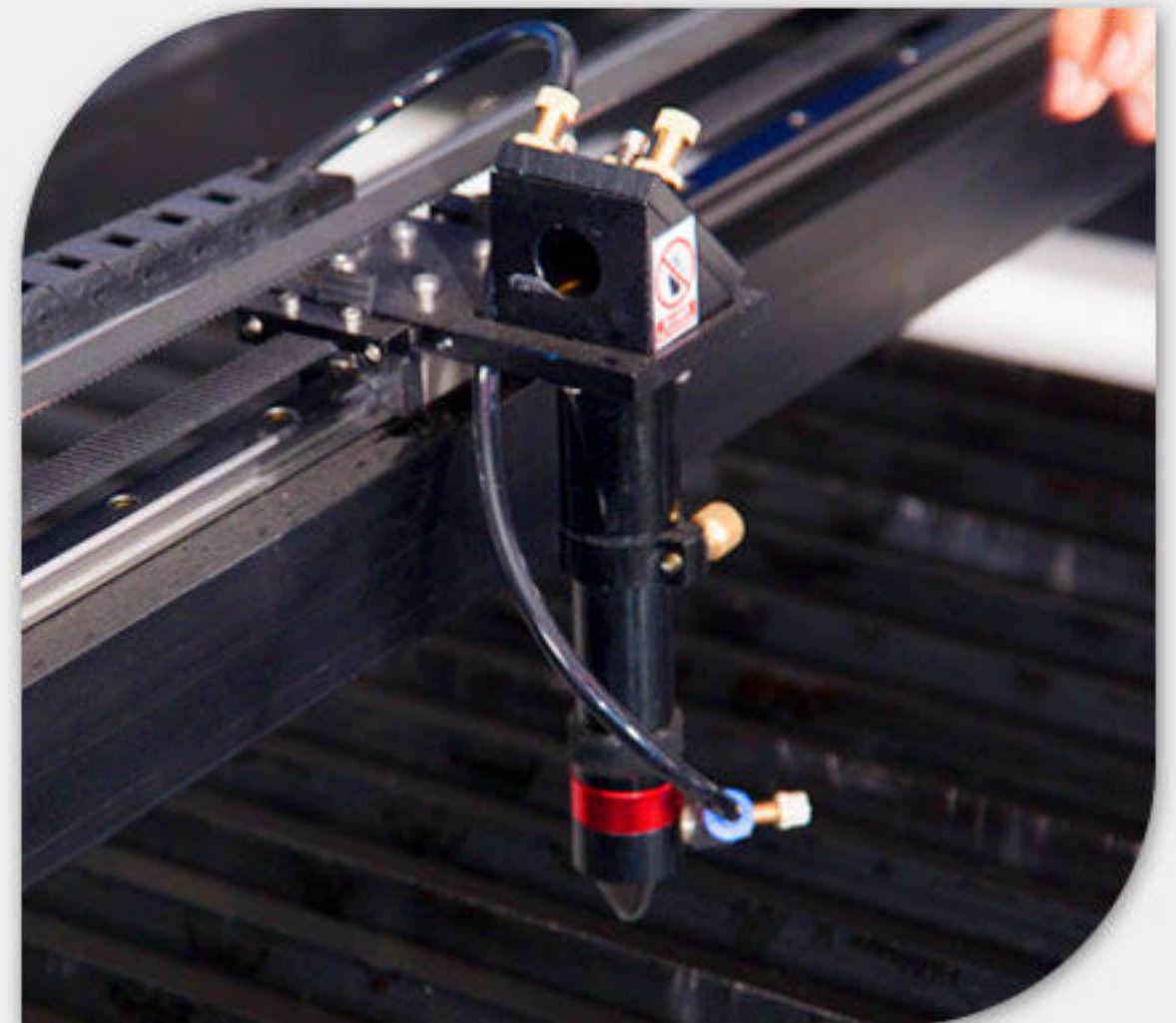

Autofocus (optional)



Red light pointer (optional)

Laser is invisible, Red laser beam to determine the cut-off point



LASER TUBE

×

Closed Co2 laser tube, long life, stable power. Installation of reinforcement settings, the laser tube is not easy to collide and cause damage when moving the machine.
(EFR, RECI, CDWJ, YONGLI, JOY. Optional)



BRAND STEPPER MOTOR

High operating accuracy, high temperature resistance, can bear the high temperature generated by high-speed operation, and low noise.

HIGH SPEED STEPPER SUBDIVISION DRIVER CONTROL SYSTEM

Adopt Chinese Top Brand "Leadshine" Step Motor and Driving System Numerical timing Simulation quantum control laser power. Little error, repetition high precision.



USA II-VI LENS

Imported USA II-VI Lens, suitable for various environments, and has high precision and high speed.

FAMOUS BRAND BELT

The ONK brand belt, wear resistance, good stability, compact structure and low noise.

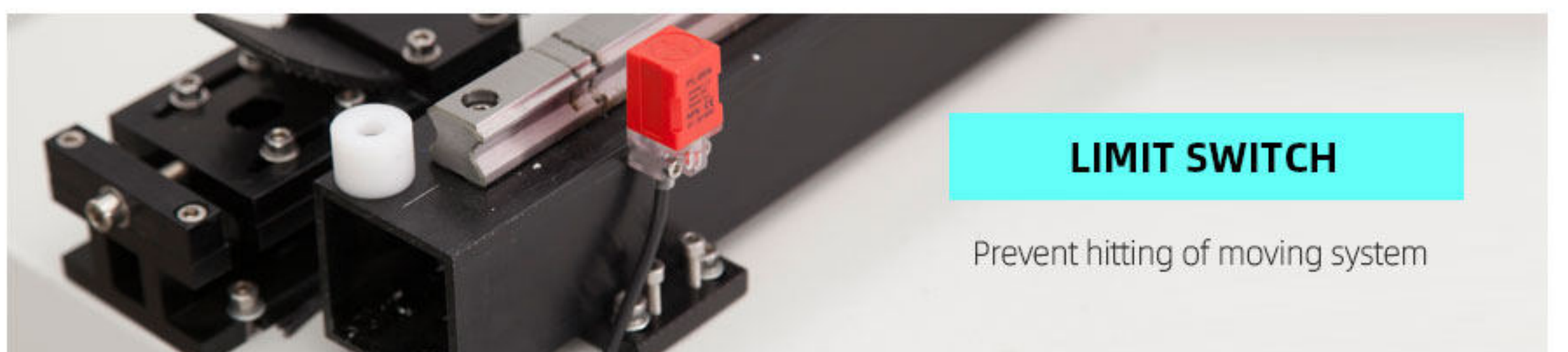

LIMIT SWITCH

Prevent hitting of moving system

LEADING CHAIN

×

The current lead and breather pipe are included in it.
Thicker, more stable
Keep the laser head from shaking



REFLECTOR

×

45° mirror adjustment set. Easy to adjust laser path.

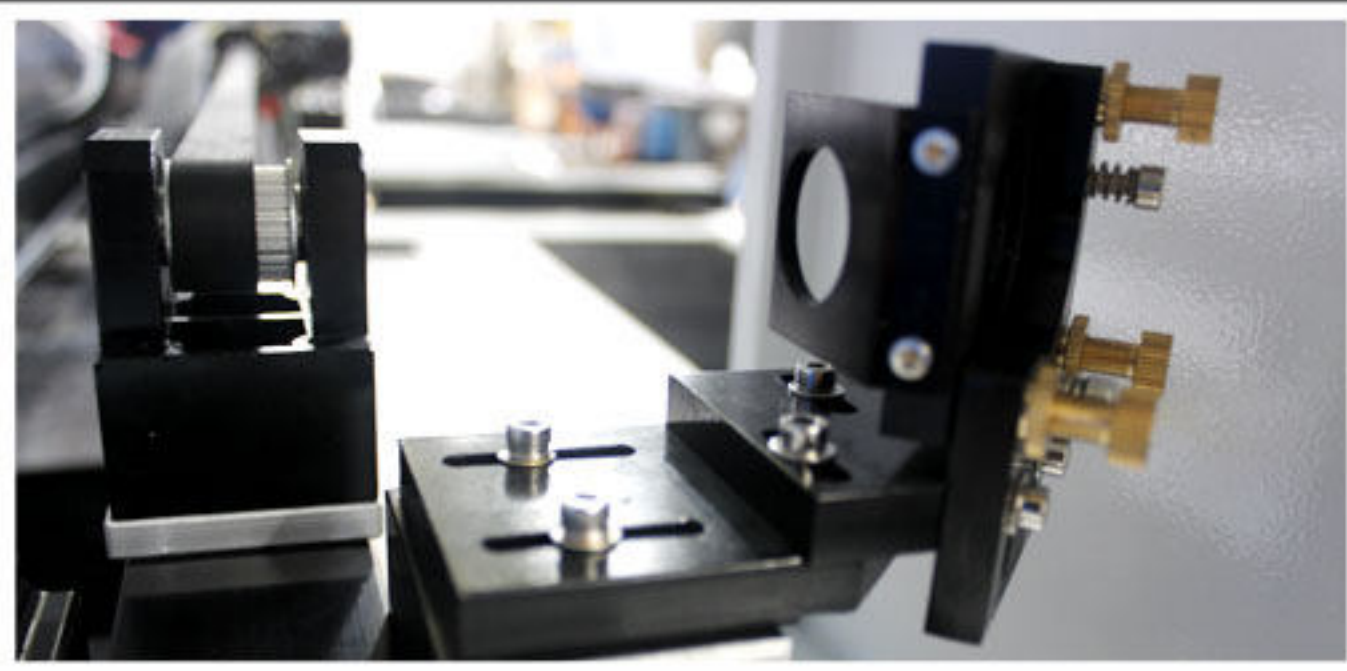

SWITCH

×

Key switch, emergency stop, LED light, Amperemeter.
USB interface & USB cable. Two kinds of transmission files.





FEATURES

×

1. Adopt advanced laser engraving and cutting control system: Ruida RDC6442 control system, the control panel support different language include Chinese, English, French, Pyccok, Portuguese, Turkish, German, Spanish, Vietnamese, Korean, Italian.

2. Standard RDWorksV8 software: It support 15 different languages, include: Chinese, English, Japanese, French, German, Portuguese, Polish, Spanish, Russian, Korean, Vietnamese, Indonesian, Italian, Turkish, Arabic.

It can compatible with many other software, like Coreldraw, Photoshop, AutoCAD, TAJIMA, etc. You can use these software to make designs, then import to Rdworks to cut or engrave.

3. RDworks software support files in different format: AI, DXF, PLT, DST, BMP, DSB, EPS, DAT, NC, RDB, GIF, JPG, JPEG, JPE, JFIF, PNG, MNG, ICO, CUR, TIF, TIFF, TGA, PCX, WBMP, WMF, EMF, JBG, J2C, JPC, PGX, RAS, PNM, PGM, PPM, SKA, RAW,

4. Storage: The main board has EMS Memory which enables the user to store more than 100 files.

5. Laser output control: Can regulate the laser power from 1-100% according to different material.

6. Interface: USB2.0 interface support connect to computer by USB cable, it also support offline work.



Wifi Control(optional)



Mobile App(optional)



Multi-lanquage

MAIN BOARD

laser cutting machine

Multi-language in LCD panel. Ruida. The interface of the control panel is simple, easy to learn, easy to pperate and the system is stable.



Free upgrade to RD-6445

POWER DISTRIBUTION BOX

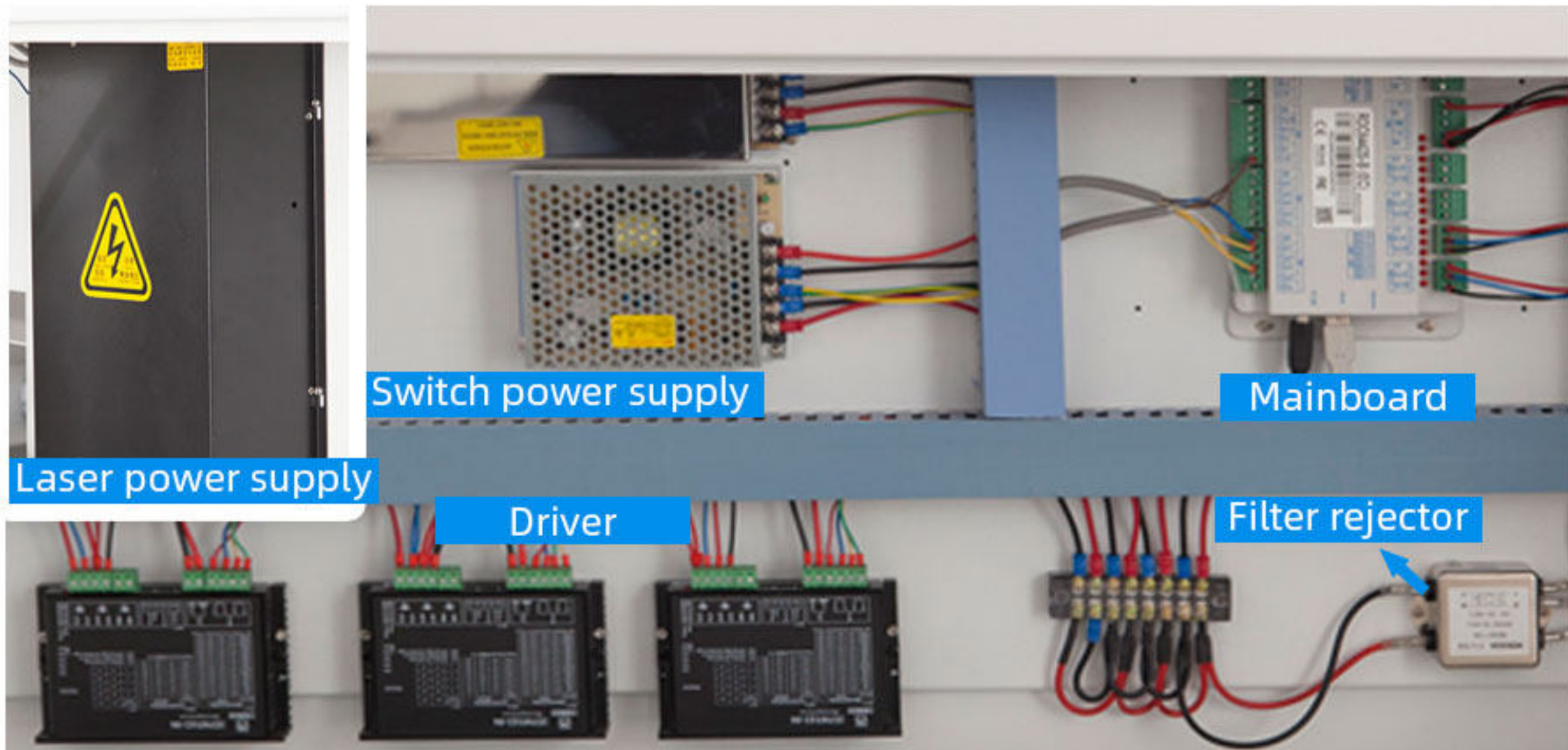

Machine detail. Take every detail seriously to ensure that the machine is stable working during service to every customer.

Coreldraw and CAD control directly

Advanced working software which can be embedded into Coreldraw and CAD, User can operate the machine buy Cor-edraw or CAD software directly.



Coreldraw



CAD



Smoke vent

A smoke exhaust system and a high-power centrifugal fan are installed behind the machine. Strong power , good smoke exhaust effect and long life.

Smoke extractor

Removes smoke and dust caused during engraving and cutting.



Water chiller

Best in china, it is for cooling the laser tube after water fill in the pipe when machine is working



Water protection

Stop the laser and protect the laser tube when the water is cut off



Waste disposal drawer

Drawer-type sample box, no sample is lost after cutting, convenient and easy to take out.

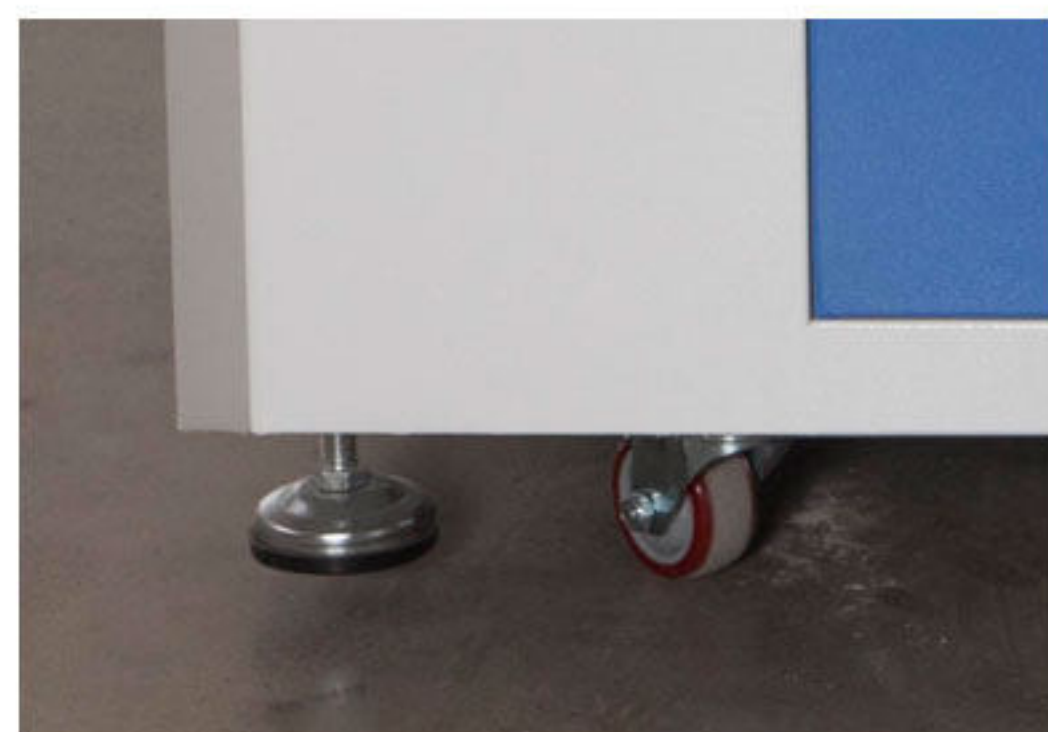

Universal wheel machine holder feet

The universal wheel at the bottom allows you to easily move the position of the machine, And there are ground feet to increase the machine's balance Performance.

Smoke purifier (optional)

Extract smoke dust , smell . oil and clean the air to avoid pollute the environment . It can be used in laser cutting , engraving , marking industries . We will equip depending on customer's demand.



Our certificate

Foster Laser Technology Co., Ltd.



PRODUCT ACCESSORIES

FOSTER LASER



S&A Water chiller



Exhaust fan



Chimney



Air pump



Tool box



Tool protection



Cardan wheel



User manual



CD or U disk



Data Line



Power Cord



Focal length ruler

PRODUCT APPLICATION

FOSTER LASER

APPLICABLE INDUSTRIES:

Model industry (construction models, aviation and navigation models and wooden toys), advertisement, decoration, arts and crafts, electronic and electric appliances, garment industry fabric leather cut, etc.

WORKING MATERIALS:

Nonmetal materials such as acrylic, MDF, wood planks (light planks, paulownia wood), bamboo ware, double color sheets, paper, leather, shells, coconut shells, ox horns, resin, animal grease, ABS boards, lampshade, etc.

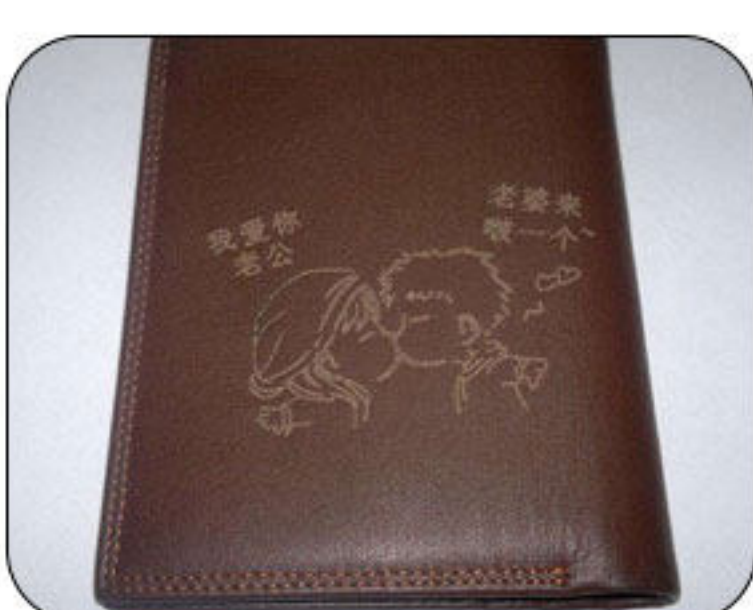

Applicable material for reference

Material	Engrave	Cut	Material	Engrave	Cut
Natural wood	√	√	Paper	√	√
Acrylic	√	√	Mylar	√	√
Glass	√	×	Press board	√	√
Double color plate	√	√	Rubber	√	√
Bamboo	√	√	Plywood	√	√
MDF	√	√	Fiberglass	√	√
Cloth	√	√	Painted metal	√	√
Leather	√	√	Plastic	√	√
Marble	√	×	Ceramic	√	×
Matte boards	√	√	Coated Metal	√	×
Stone	√	×	Other materials	Inquire us, we will test for you	

Cutting thickness of different laser power for reference

Laser power (W)	Acrylic(mm)	Plywood(mm)	MDF(mm)
40W	3	2	1.5
60W	8	5	3
80W	12	8	6
100W	15	12	9
150W	25	20	15

* The above data is for reference only

PACKAGING SHIPPING

FOSTER LASER



Machine cleaning and
Protective oil processing



Wrapping with
protective film



Wooden box sealing



Container Sealing
and Transportation



container loading



Forklift moving goods

OUR REVIEWS

FOSTER LASER

Supplier Service: **Very satisfied** (5 stars) 10 Jul 2020
On-time Shipment: **Very satisfied** (5 stars)



1390 cnc co2 laser cutting machine with CCD camera...

★★★★★

Good quality built and good support from the seller. Nice machine all around. Just had to find a version of corel draw in english. Laser was well aligned despite shipping and didn't have to do alignment myself. So very satisfied all around. I prefer using some industrial water...

[Read more](#)

0

Supplier Service: **Very satisfied** (5 stars) 12 Jun 2020
On-time Shipment: **Very satisfied** (5 stars)



50w fiber laser marking machine 50w raycus with rot...

★★★★★

great service and trustworthy! will definitely buy again!!

0

Supplier Service: **Very satisfied** (5 stars) 22 Jun 2020
On-time Shipment: **Very satisfied** (5 stars)



laser engraving machine for perfume bottle 50w 4060...

★★★★★

the machine came with no scratches and no any damage, also the supplier was to active and helped me even after purchasing

0

Supplier Service: **Very satisfied** (5 stars) 25 May 2020
On-time Shipment: **Very satisfied** (5 stars)



Factory directly 150w 180w 220w RD6442S recti stainl...

★★★★★

wow just wow very great product. very satisfied customer here..the seller is very responsive..thank you so much

0

Supplier Service: **Very satisfied** (5 stars)
On-time Shipment: **Satisfied** (5 stars)



Hot sale 1325 mixed 300w laser cutting machine for stainle...

★★★★★

good services

Supplier Service: **Very satisfied** (5 stars)
On-time Shipment: **Very satisfied** (5 stars)



cheap price 1325 co2 laser engraving cutting machine/ cnc l...

★★★★★

Everything with this seller goes just as they promised. I'm satisfied all details about this transaction.

Machine need some fine tuning but they always need after install and delivery.

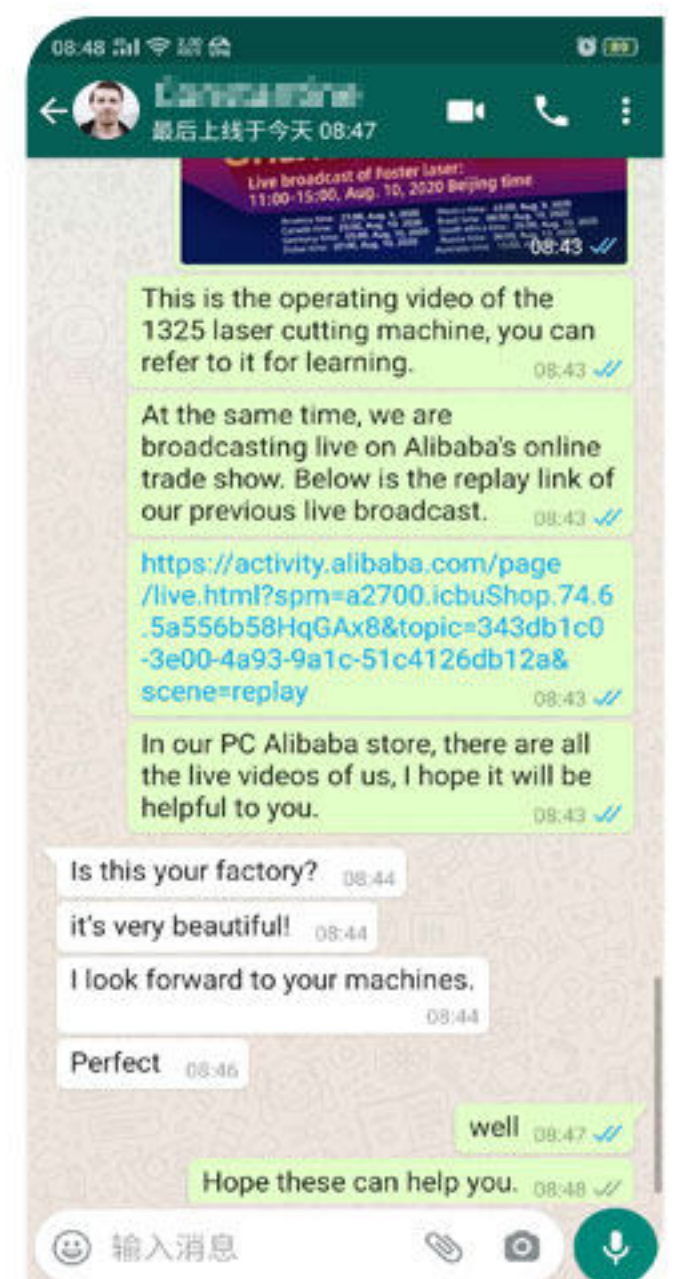

Trade Assurance Supplier

 Trade Assurance

Protect Your Alibaba.com Orders

Trade Assurance protects online orders when payment is made through Alibaba.com.



Have Greater Peace of Mind

In the event that either Product Quality or On-Time Shipment varies from what you and the supplier had agreed to in the Trade Assurance online order, we will offer you assistance in reaching a satisfactory outcome, including getting your money back



Product Quality



On Time Shipment

Company and Factory

Liaocheng Foster Laser Science&Technology Co.,Ltd is a professional manufacturer of laser engraving machine,laser cutting machine,laser marking machine for 12years .Since 2004, Foster Laser focused on the development and production of various types of laser engraving/cutting/marking machine with the advanced management, strong research strength and steady globalization strategy, Foster Laser establish more perfect product sales and service system in China and around the world, make the world's brand in laser industry.

Our target is "scientific management, high quality, high reputation and takes continuous development as our policy, regards customers as our center, double win with our customers", and we adhere to our tenet of "take the market demand as the guide, continue to take innovation and make improvement". We will try our best to provide the high quality products and perfect service for clients.

Furthermore,we pay much attention to after-sales service. Good service and good quality is same important for Foster Laser will follow the spirit "Credibility and Integrity", try best to provide customer more super product and better service.

Foster Laser—reliable professional Laser equipment supplier

Welcome to cooperate with us and achieve win-win!



Office and Team

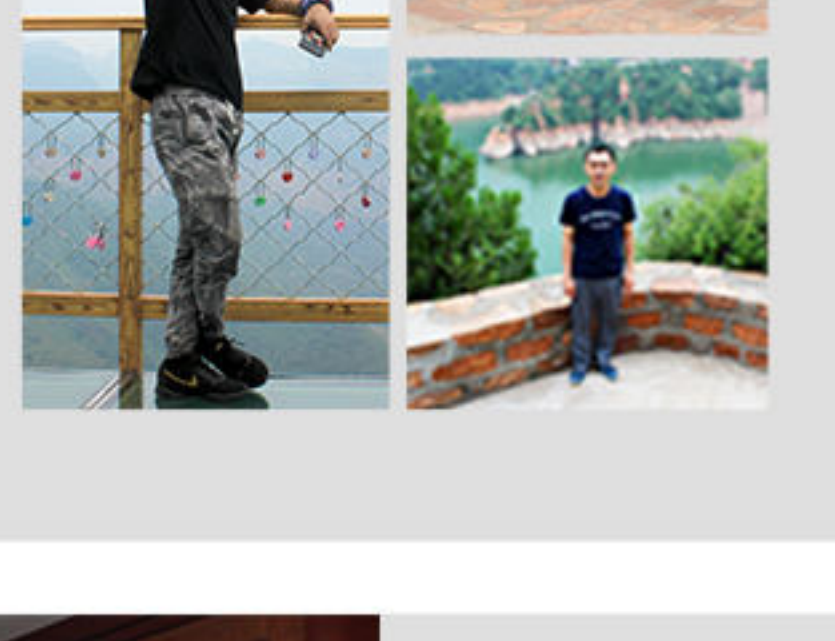
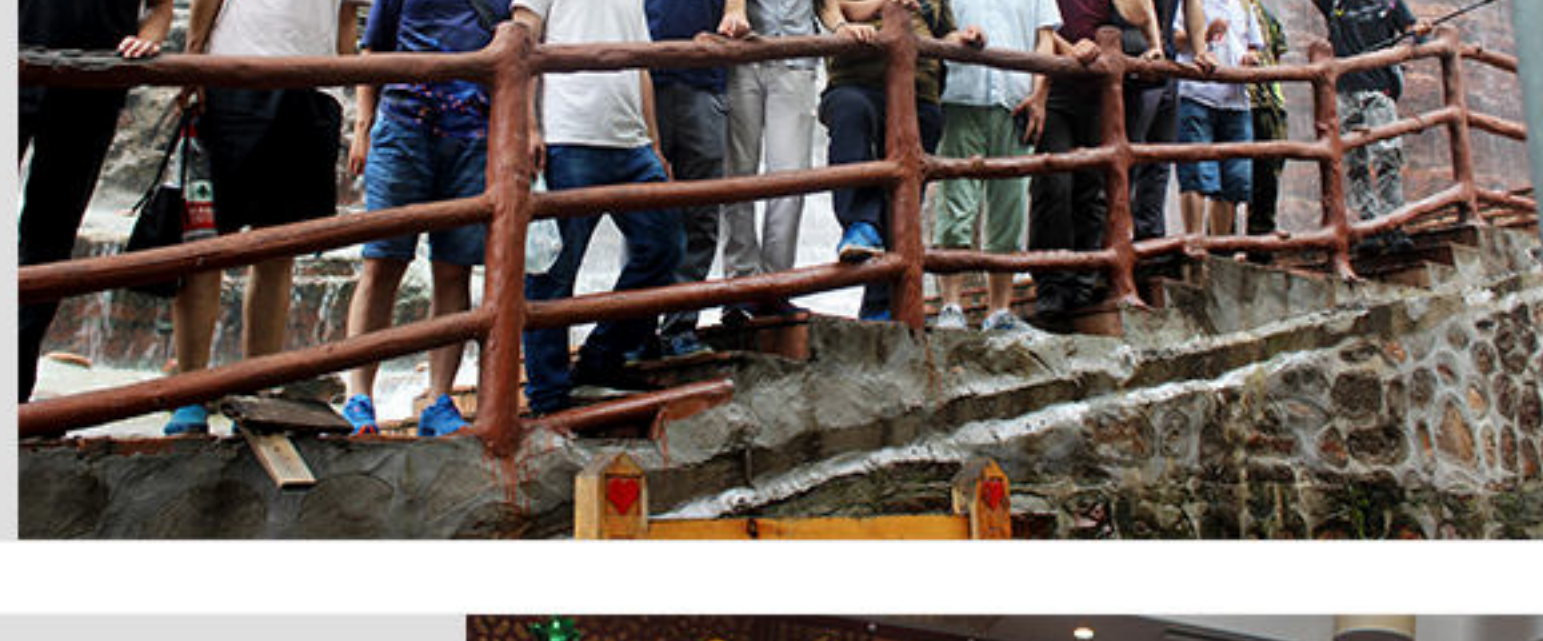
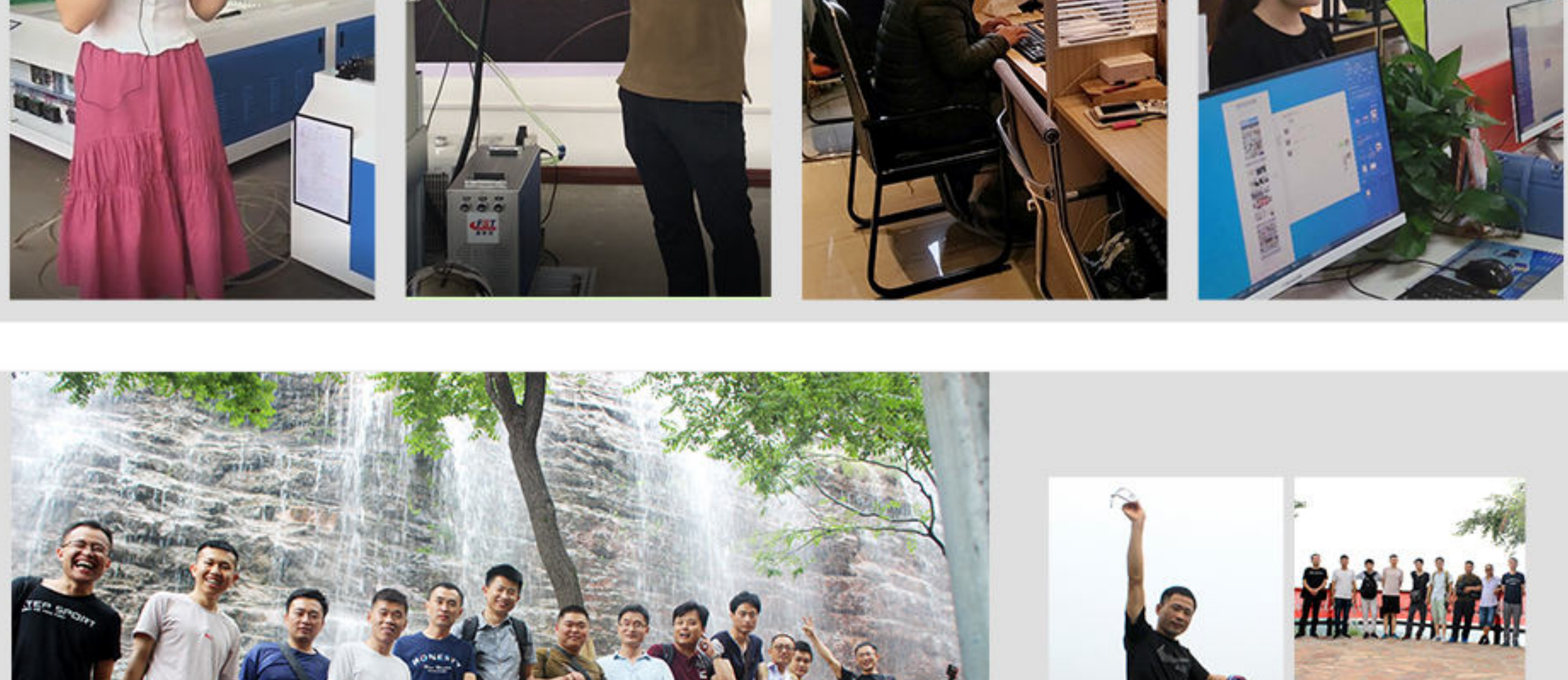
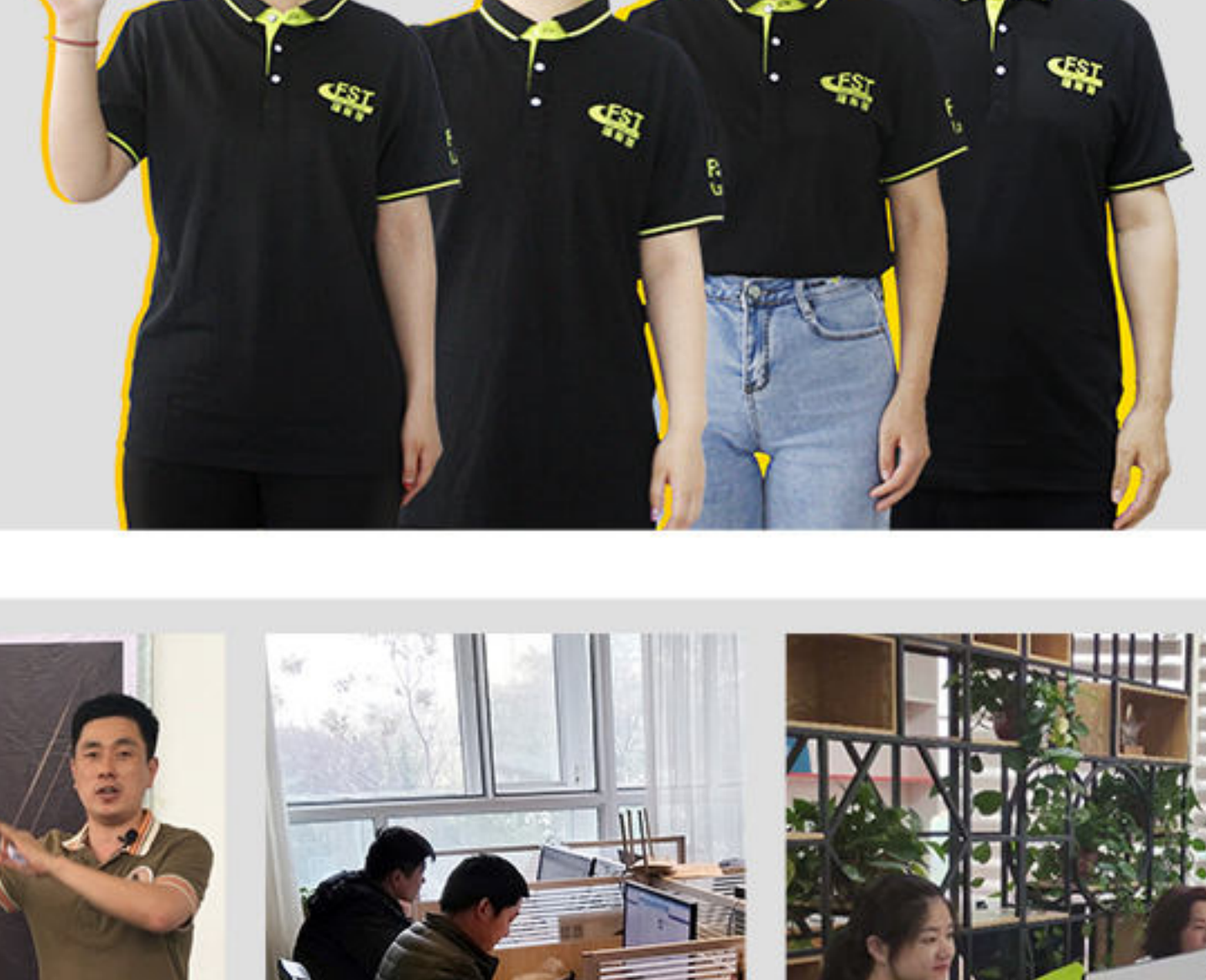

Our Exhibition



F A Q

Q1. Before sending me an inquiry on our cnc laser, it is better for you to provide me the following information:

- 1)Your metal or non-metal material size. Because in our factory, we have different models according to working area.
- 2)Your materials.
Metal/Acrylic/plywood/MDF?
- 3)You want to engrave or cut?
If cut, could you tell me your cutting thickness? Because different cutting thickness need different laser tube power and laser power supplier.

Q2. If we don't know how to use the machine,can you teach us?

Yes, We will send you manual and guide vedio in English, it can teach you how to operate the machine. If you still can not learn how to use it, we can help you by "Teamviewer" online helpsoftware.Or we can talk by phone, email or skype

Q3.How long is the delivery time?

For standard machines, it would be 3-5 days; For non-standard machines and customized machines according to client's specific requirements, it would be 7 to 10 days.

Q4. Quality Control:

The whole production procedure will be under regular inspection and strict quality control. The complete machine will be tested to make sure they can work very well before being out of factory. Our machine passed CE Certificate, meet European and American standard, were exported to more than 100 Countries.

Q5. Do you arrange shipment for the machines?

Yes, dear esteemed customers, for FOB or CIF price, we will arrange shipment for you. For EXW price, clients need to arrange shipment by themselves or their agents.

Our services



- 1. warranty for 1 years.
- 2. Maintenance for whole life.
- 3. We will provide the consumable parts at an agency price.
- 4. 24 hours online service, free technical support.
- 5. Machine has been adjusted before delivery, operation disk is included in the delivery. If there is any other questions, pls kindly tell me.
- 6. We have manual instruction and CD (Guiding Videos) for software Installation, operation and machine's using and maintenance.