

CO2 RF LASER MARKING MACHINE



ADVANTAGES | CO2 RF LASER MARKING MACHINE



- 1 Advanced CO2 metal laser tube, life more than 20,000 hours.
- 2 High precision and permanent marking performance .
- 3 Air cooling, no maintenance
- 4 Can mark on most of non-metals

Co2 laser marking engraving machine can engrave serial number, picture, logo, random number, bar code, 2d barcode and various arbitrary patterns and text on flat plate and also cylinders.

The main processing object is non-metal, widely used in craft gifts, furniture, leather clothing, advertising signs, model making food packaging, electronic components, fixtures, glasses, buttons, label paper, ceramics, bamboo products, product identification, serial number, pharmaceutical packaging, printing plate making, shell nam-plate, etc



Applicable Materials: Carving materials mainly include bamboo and wood products, paper, cloth, leather, plexiglass, epoxy resin, acrylic, polyester resin and other non-metallic materials.



Acrylic



Bamboo



Glass Cup



Paper

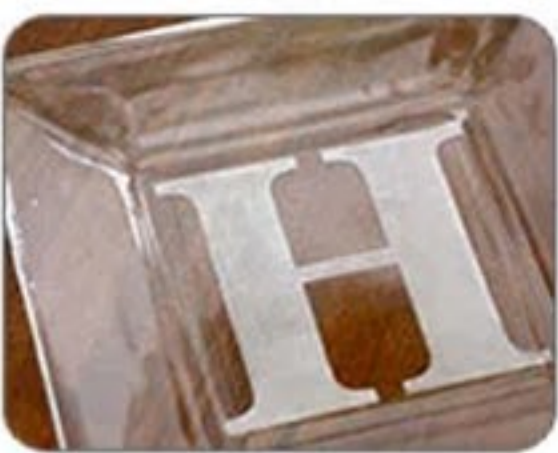

Glass



Jeans



Leather



Wood box

CO2 Laser Marking Engraving Machine Specifications

Products Name	CO2 Laser Marking Machine
Types & Model	FST Ezcad-Series
Laser Source Brand	DAVI
Laser Power	20W, 30W ,50W, 60W, 100W
Laser Wavelength	10.6um
Max Mar Speed	7000mm/s
Control Card	Original EZCAD from JCZ brand
Filed Lens Brans	wavelength
Galvo Head	Sino Galvo
Marking Area	110*110mm to 300*300mm
Mininum Line Width	0.015mm
Mininum Character	0.2mm
Operation System	Win XP / 7 / 8 / 10 (32 bit, 64 bit)
Power Supply	AC110V / 220V+10% ,50HZ / 60HZ
Operation Environment	Working temperature: 0°-40°,

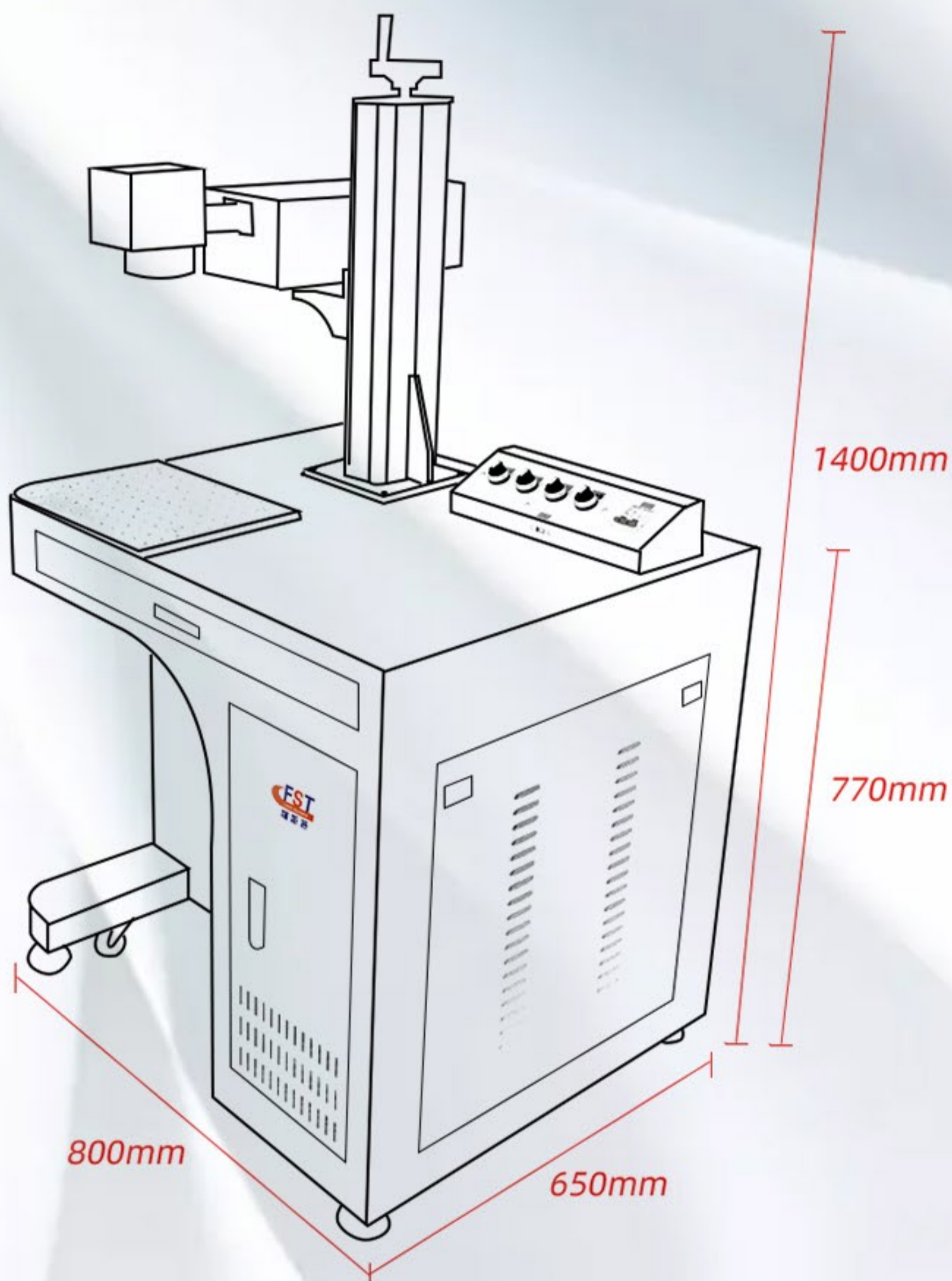

»» FIELD LENS

We use famous brand to provides precision laser. Standard 110x110mm marking area. Optional 150x150mm, 200x200mm, 300x300mm etc.

»» GALVO HEAD

Famous brand Sino-galvo, high speed galvanometer scan adopting SCANLAB technology, digital signal, high precision and Speed.

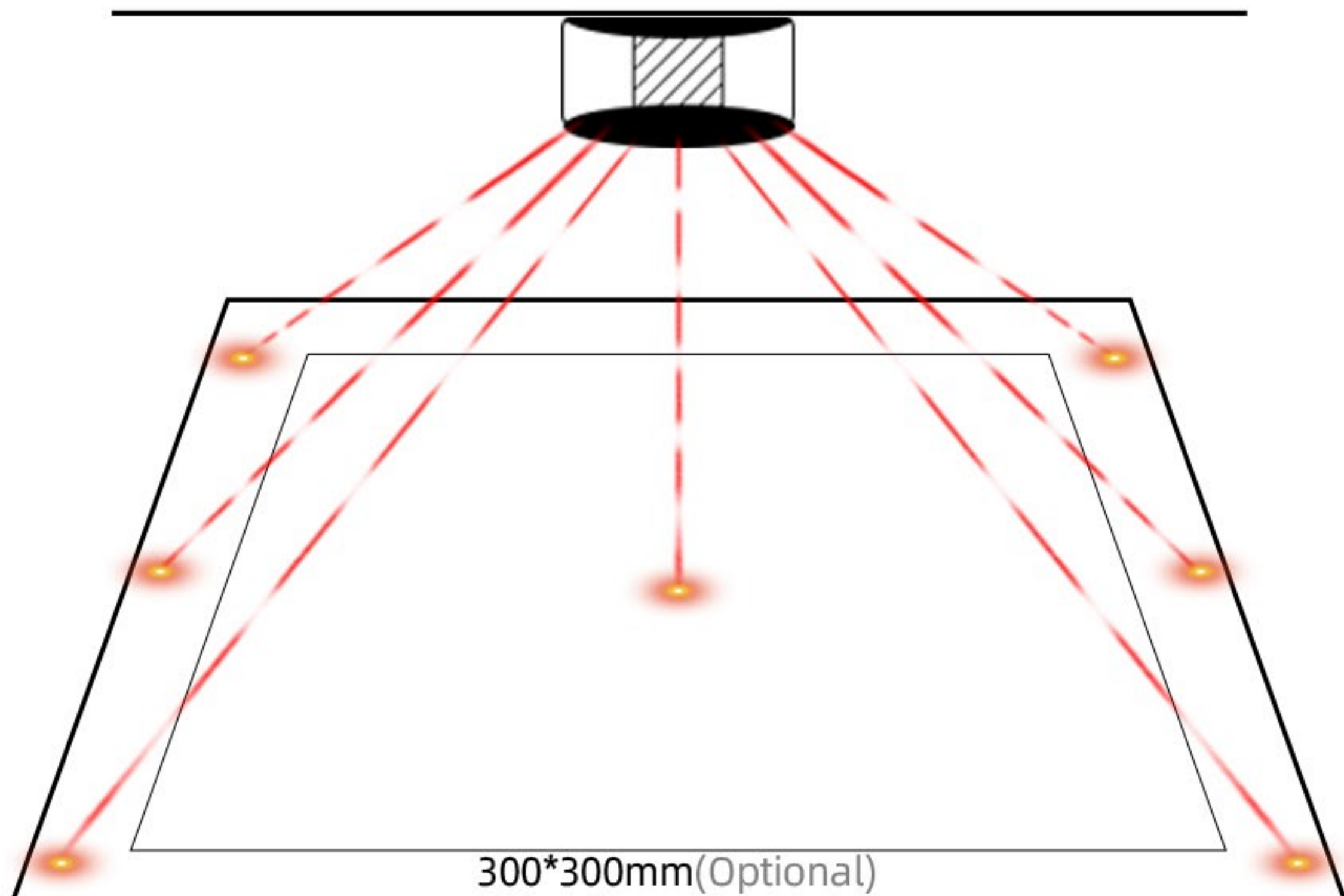

»» LASER SOURCE

Excellent Davi Laser Source . no need maintenance , long life more than 20,000 hours We can also configure the other brand source like SYNRAD Coherent.



VS



✔ Life more than 20,000 hours

✔ Air cooling, no maintenance

✘ Life is around 2,000 hours

✘ Water cooling , need maintenance

»» JCZ CONTROL BOARD



① Ezcad genuine products

② User-friendly interface

③ Functional diversity

④ High stability

⑤ High precision.



»» EZCAD CONTROL SOFTWARE

1. Powerful editing function.
2. Friendly interface.
3. Easy to use.
4. Support Microsoft Windows XP, VISTA, Win7, Win10 system.
5. Support ai, dxf, dst, plt, bmp, jpg, gif, tga, png, tif and other file formats.

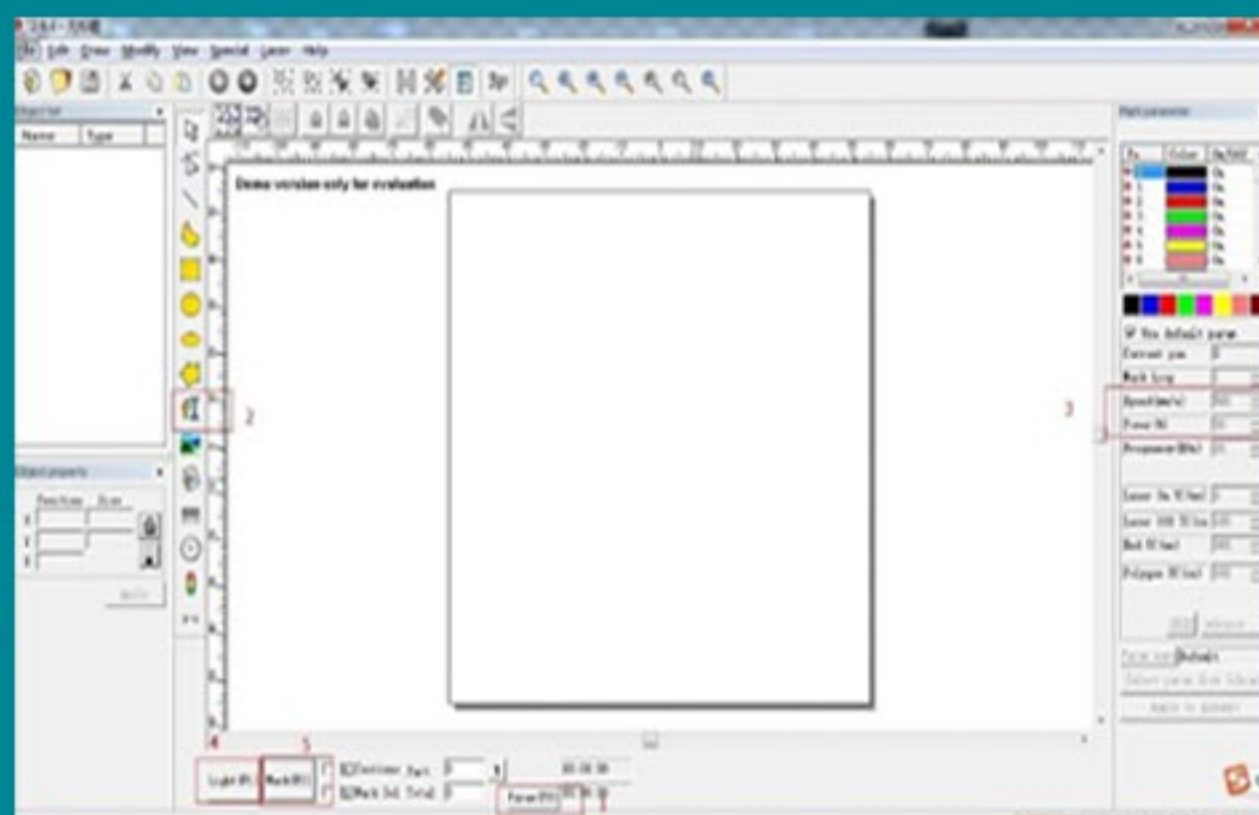



»» DOUBLE RED LIGHT POINTER (OPTIONAL)

When two red light coincides best focus. Double red light pointer help customers make focus quickly and easily.

»» RED LIGHT PREVIEW

Adopt Red light preview to show the laser path since laser beam is in-visible

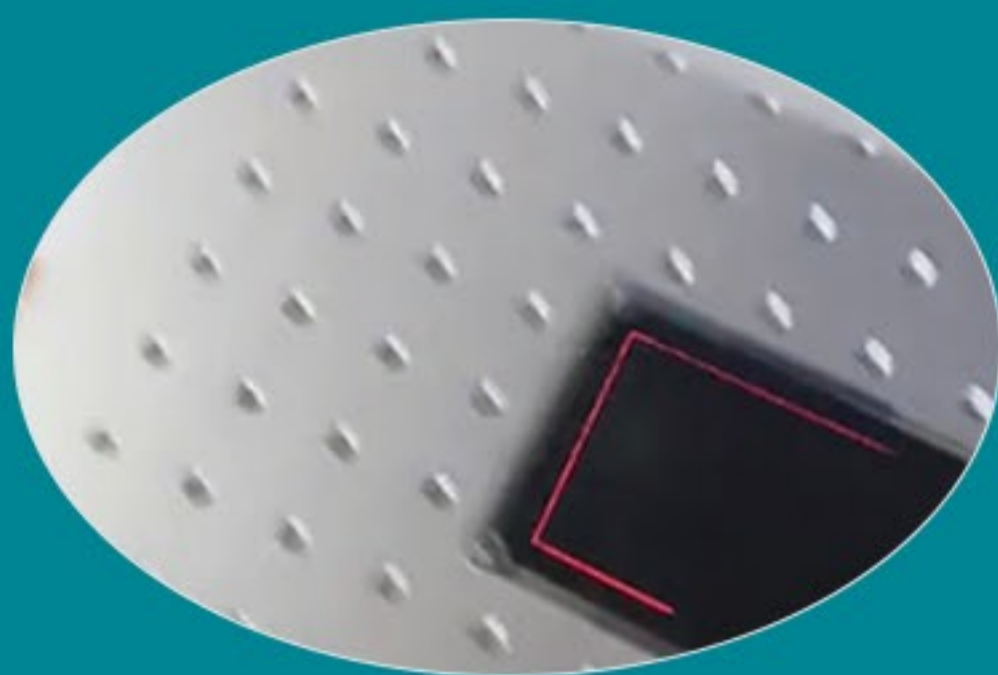

»» WORKING PLATFORM



Alumina working platform and imported precise beeline device.

Flexibility mesa have multiple screw holes, convenient and custom installation, special fixture industry platform.



»» FIXTURE (OPTIONAL)

- 1 . easy to put kinds of materials on the worktable
- 2 . There are multiple flexible screw holes on the worktable convenient for customized installtion



»» MARKING RULER AND ROTATING HANDLE

Enables customers to precisely position for fast engraving. Adapting To Different Products Height.



»» POWER SUPPLY

Brand selection:
Shanghai Hengfu, Taiwan
Meanwell



»» FOOT SWITCH

It can control the laser on and off.
make the operate more
convenient.

»» GOGGLES (OPTIONAL)

Can protect eyes from laser
wave 1064nm, let the
operate more safe.



ROTATION AXIS AND PLATFORMS (OPTIONAL)



ROTARY CHUCK

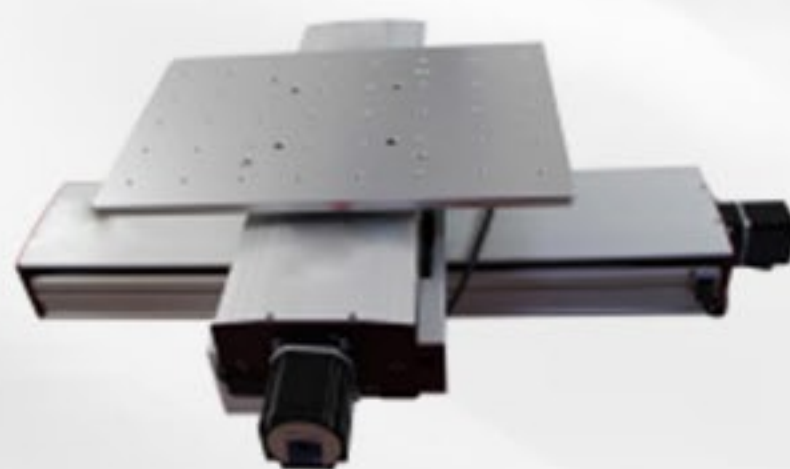
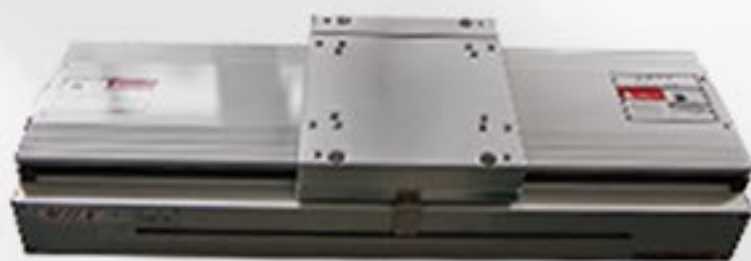
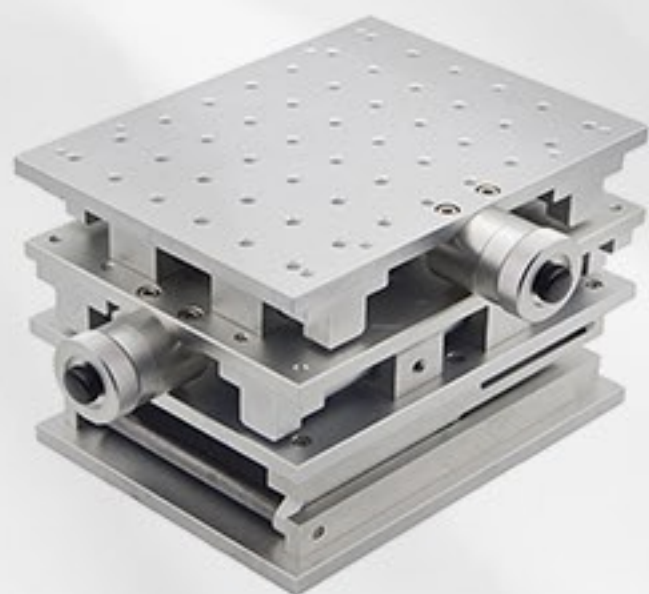

2D / 3D TABLE AND EXTENDED PLATFORM

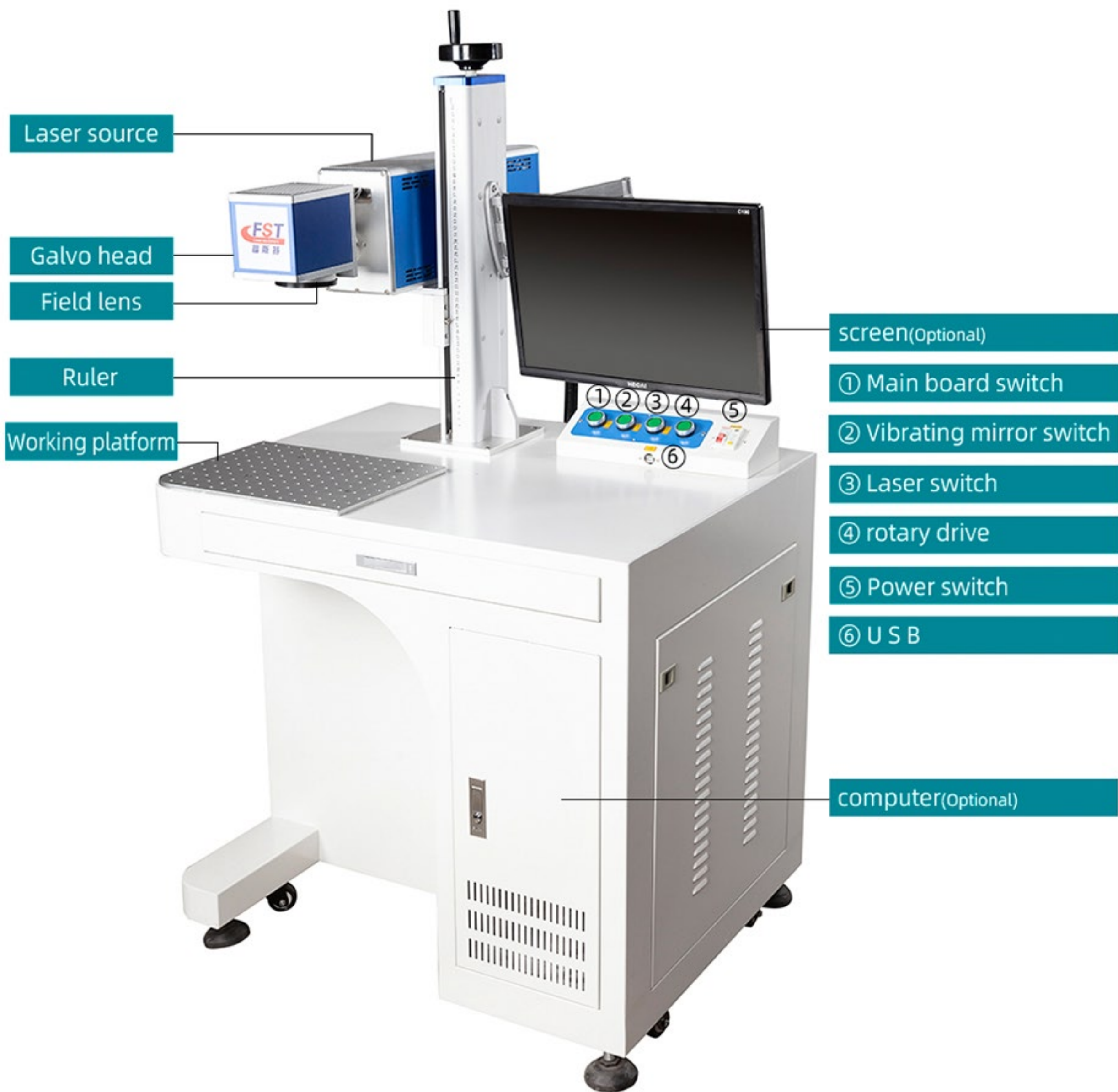

DELIVER GOODS | CO2 RF LASER MARKING MACHINE



Machine cleaning and
Protective oil processing



Wrapping with
protective film



Wooden box sealing



Container Sealing
and Transportation



container loading



Forklift moving goods

ENCLOSURE | CO2 RF LASER MARKING MACHINE



Tool protection



Focal length ruler



Data Line



Power Cord, Ground wire



U disk



Wrench



Foot Switch



USER MANUA

Supplier Service: **Acceptable** (3 stars) 03 Aug 2020
 On-time Shipment: **Very satisfied** (5 stars)



china cheap laser engraving machine 4060 laser engr...



Fosterlaser is the best supplier on Alibaba I have met

👍 0

Supplier Service: **Very satisfied** (5 stars) 25 May 2020
 On-time Shipment: **Very satisfied** (5 stars)



20W fiber laser marking machine



Honest and good seller. Sent everything on time (even considering the global epidemic at the time of my order). The machine came well packed. Nothing is damaged, everything works, the kit is complete, exactly what we agreed on. So all is well, I am completely satisfied. Thanks!

👍 0

Supplier Service: **Very satisfied** (5 stars) 03 Aug 2020
 On-time Shipment: **Very satisfied** (5 stars)



3kw cnc fiber laser cutting machine for 12mm iron al...



The machine is perfect and the service is professional, I am very satisfied

👍 0



Supplier Service: **Very satisfied** (5 stars) 12 Jun 2020
 On-time Shipment: **Very satisfied** (5 stars)



50w fiber laser marking machine 50w raycus with rot...



great service and trustworthy! will definitely buy again!!

👍 0

Supplier Service: **Very satisfied** (5 stars) 17 May 2020
 On-time Shipment: **Very satisfied** (5 stars)



30w RF LASER MARKING MACHINE



Fast delivery, I recommend. I look forward to another purchase

👍 0



Our certificate

Foster Laser Technology Co., Ltd.



Company and Factory

Liaocheng Foster Laser Science&Technology Co.,Ltd is a professional manufacturer of laser engraving machine,laser cutting machine,laser marking machine for 12years .Since 2004, Foster Laser focused on the development and production of various types of laser engraving/cutting/marking machine with the advanced management,strong research strength and steady globalization strategy, Foster Laser establish more perfect product sales and service system in China and around the world, make the world's brand in laser industry.

Our target is "scientific management, high quality, high reputation and takes continuous development as our policy, regards customers as our center, double win with our customers", and we adhere to our tenet of "take the market demand as the guide, continue to take innovation and make improvement". We will try our best to provide the high quality products and perfect service for clients.

Furthermore,we pay much attention to after-sales service. Good service and good quality is same important for Foster Laser will follow the spirit "Credibility and Integrity", try best to provide customer more super product and better service.

Foster Laser--reliable professional Laser equipment supplier!

Welcome to cooperate with us and achieve win-win!



Office and Team



Our Exhibition

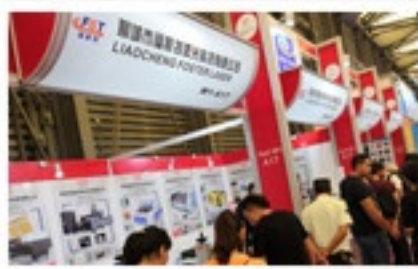
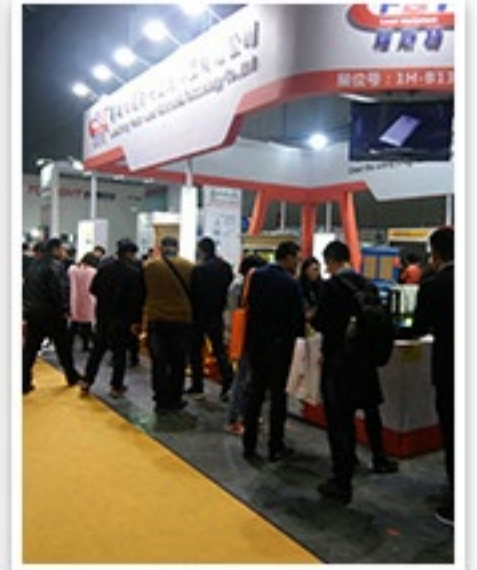
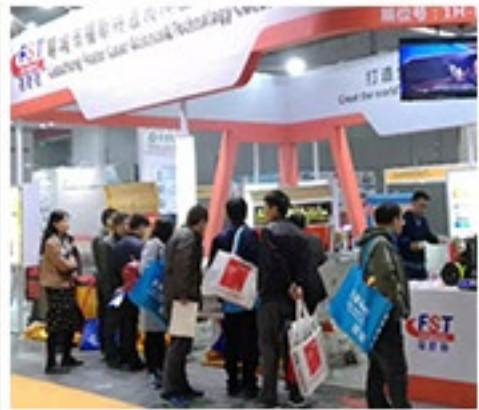
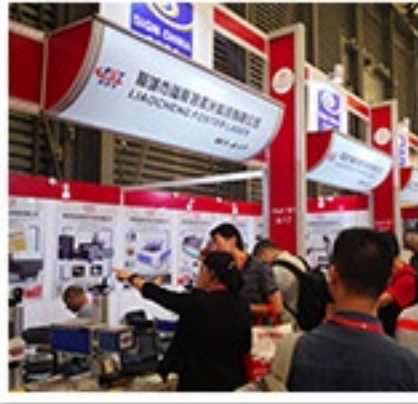
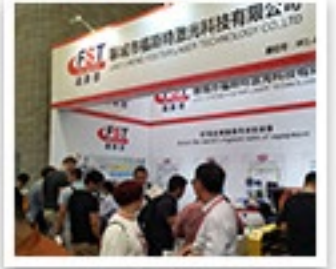
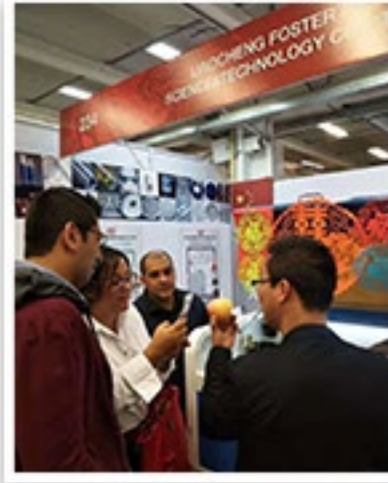

Our services

- 
- A woman in a blue business suit and headset is working on a laptop. The background is a light blue gradient with a faint image of the woman and her laptop.
1. warranty for 2 years.
 2. Maintenance for whole life.
 3. We will provide the consumable parts at an agency price.
 4. 24 hours online service, free technical support.
 5. Machine has been adjusted before delivery, operation disk is included in the delivery. If there is any other questions, pls kindly tell me.
 6. We have manual instruction and U drive (Guiding Videos) for software Installation, operation and machine's using and maintenance.